

U16 F40

Competitors/Compétiteurs

#	Name/Nom	Grade	Club	1	2	1	2	1	2	W/G	Pts	Pos
1	ROWLAND Delayne	3 Kyu	AB	XX	10	XX		XX		1	10	2
2	TESANOVIC Ema	3 Kyu	AB		XX	10	XX	10	XX	2	20	1

Matches/Matches

Match	White/Blanc			Blue/Bleu	Res/Rés	Tim/Tmp	Code
B-66	ROWLAND Delayne	1	2	TESANOVIC Ema	10 - 0	2:43	IPO
B-75	ROWLAND Delayne	1	2	TESANOVIC Ema	0 - 10	1:00	IPO
B-80	ROWLAND Delayne	1	2	TESANOVIC Ema	0 - 10	1:51	IPO

Results/Résultats

Pos	Name/Nom
1	TESANOVIC Ema, AB
2	ROWLAND Delayne, AB

U16 F44

Competitors/Compétiteurs

#	Name/Nom	Grade	Club	1	2	3	4	5	W/G	Pts	Pos
1	BURTON Kennedy (Grace)	3 Kyu	SK	XX					0	0	5
2	LIN Elicia	2 Kyu	ON	10	XX				1	10	4
3	SOMERS Andrée-Ann	1 Kyu	QC	10	10	XX			2	20	3
4	CHOW Christine	3 Kyu	BC	10	1	10	XX	1	4	22	1
5	GOTO Tami	2 Kyu	BC	10	10	7		XX	3	27	2

Matches/Matches

Match	White/Blanc			Blue/Bleu	Res/Rés	Tim/Tmp	Code
A-26	CHOW Christine	4	5	GOTO Tami	1 - 0	3:00	YUS
A-27	BURTON Kennedy (Grace)	1	2	LIN Elicia	0 - 10	0:24	IPO
A-37	SOMERS Andrée-Ann	3	4	CHOW Christine	0 - 10	0:30	WIP
A-38	BURTON Kennedy (Grace)	1	5	GOTO Tami	0 - 10	1:11	WIP
A-45	LIN Elicia	2	3	SOMERS Andrée-Ann	0 - 10	0:09	IPO
A-46	BURTON Kennedy (Grace)	1	4	CHOW Christine	0 - 10	2:20	WIP
A-57	SOMERS Andrée-Ann	3	5	GOTO Tami	0 - 7	3:00	WAZ
A-58	LIN Elicia	2	4	CHOW Christine	0 - 1	3:00	YUS
A-65	BURTON Kennedy (Grace)	1	3	SOMERS Andrée-Ann	0 - 10	1:36	WIP
A-66	LIN Elicia	2	5	GOTO Tami	0 - 10	0:00	FUS

Results/Résultats

Pos	Name/Nom
1	CHOW Christine, BC
2	GOTO Tami, BC
3	SOMERS Andrée-Ann, QC
4	LIN Elicia, ON
5	BURTON Kennedy (Grace), SK

U16 F48

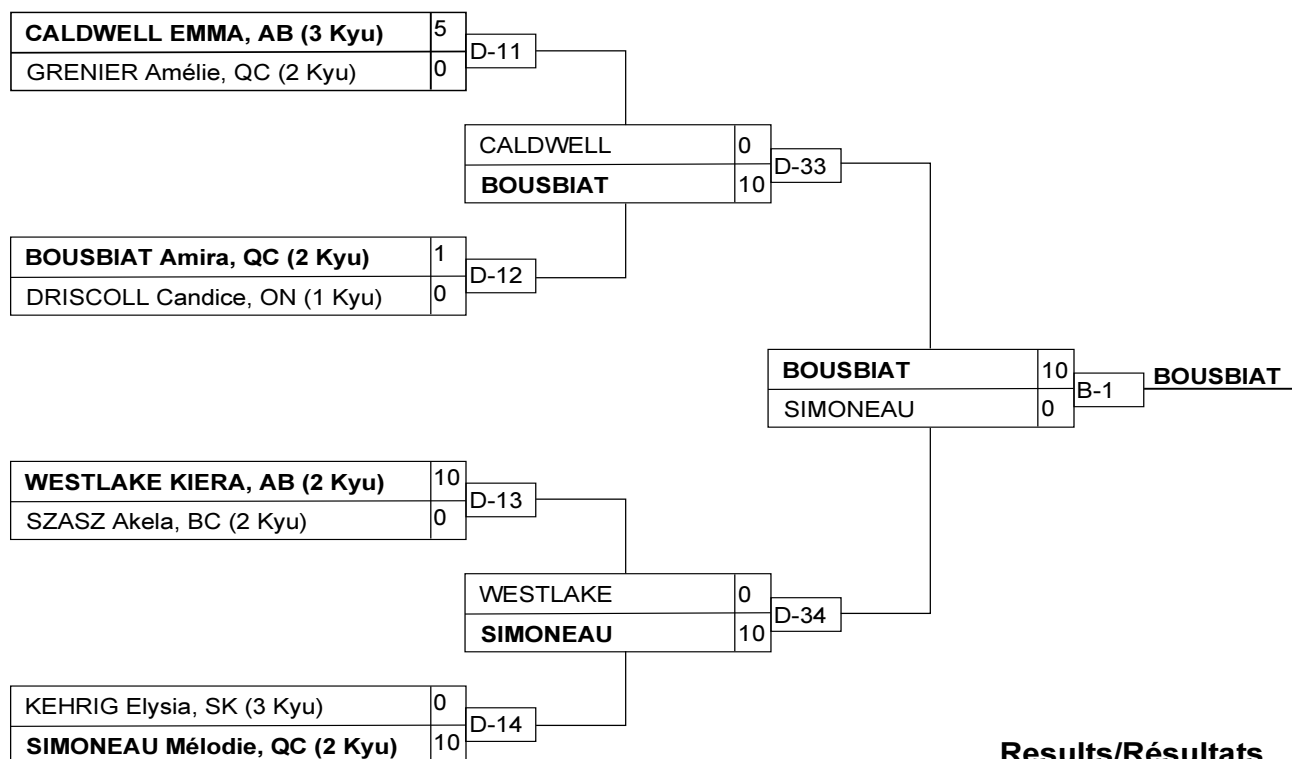

Results/Résultats

Pos	Name/Nom
1	BOUSBIAT Amira, QC (2 Kyu)
2	SIMONEAU Mélodie, QC (2 Kyu)
3	SZASZ Akela, BC (2 Kyu)
3	WESTLAKE KIERA, AB (2 Kyu)

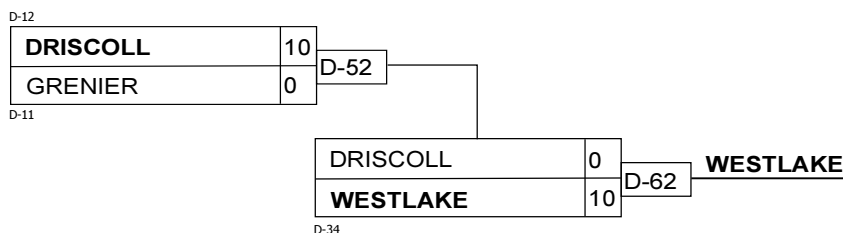
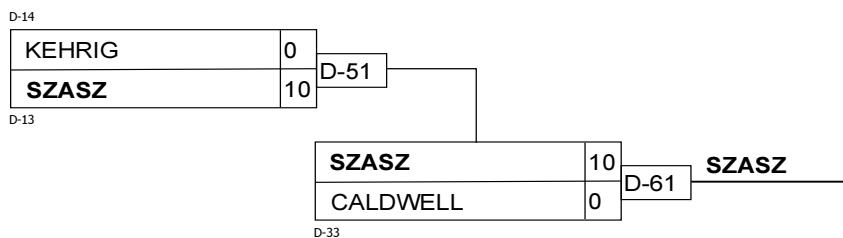

U16 F57

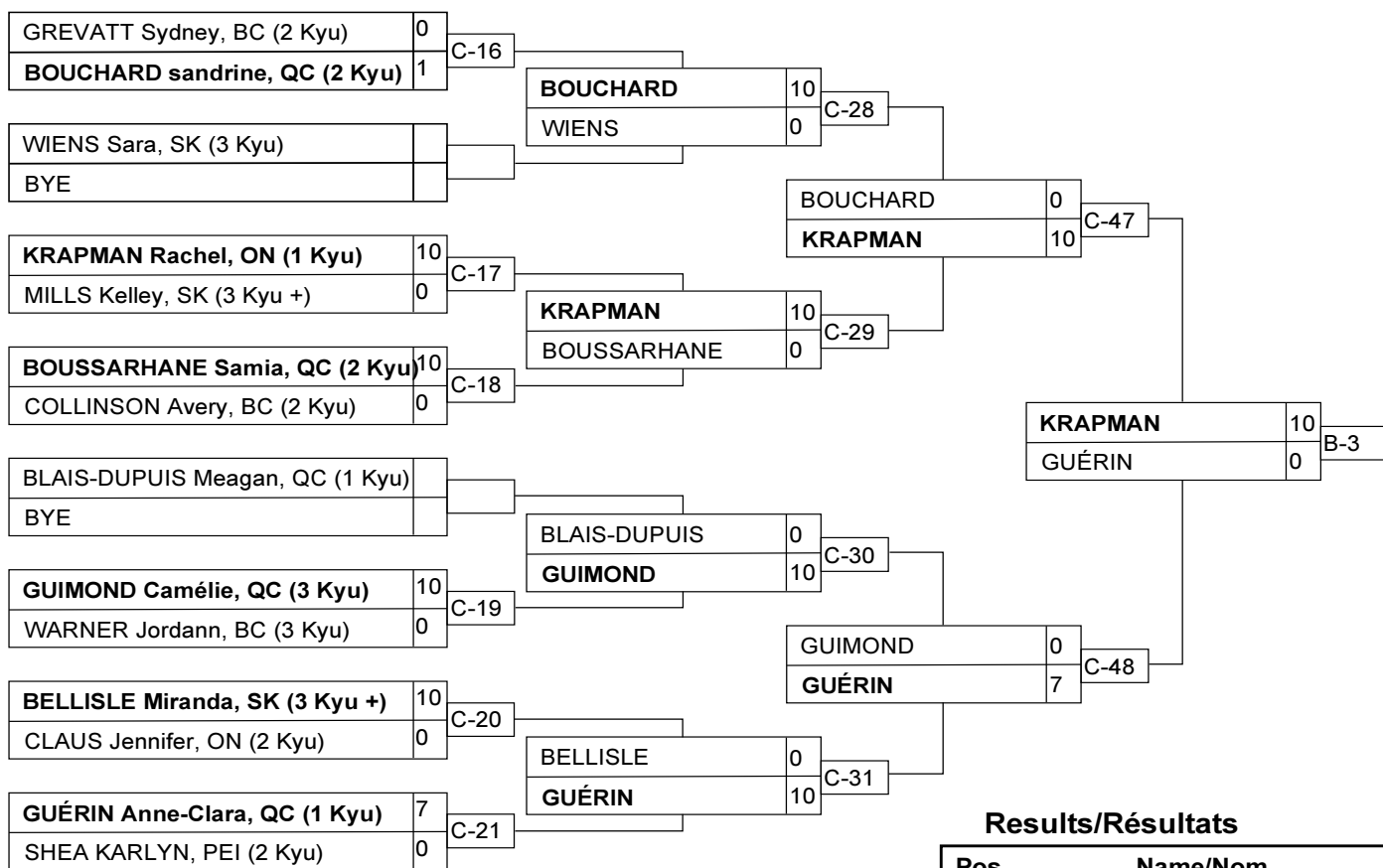

Results/Résultats

Pos	Name/Nom
1	KRAPMAN Rachel, ON (1 Kyu)
2	GUÉRIN Anne-Clara, QC (1 Kyu)
3	BELLISLE Miranda, SK (3 Kyu +)
3	BOUSSARHANE Samia, QC (2 Kyu)

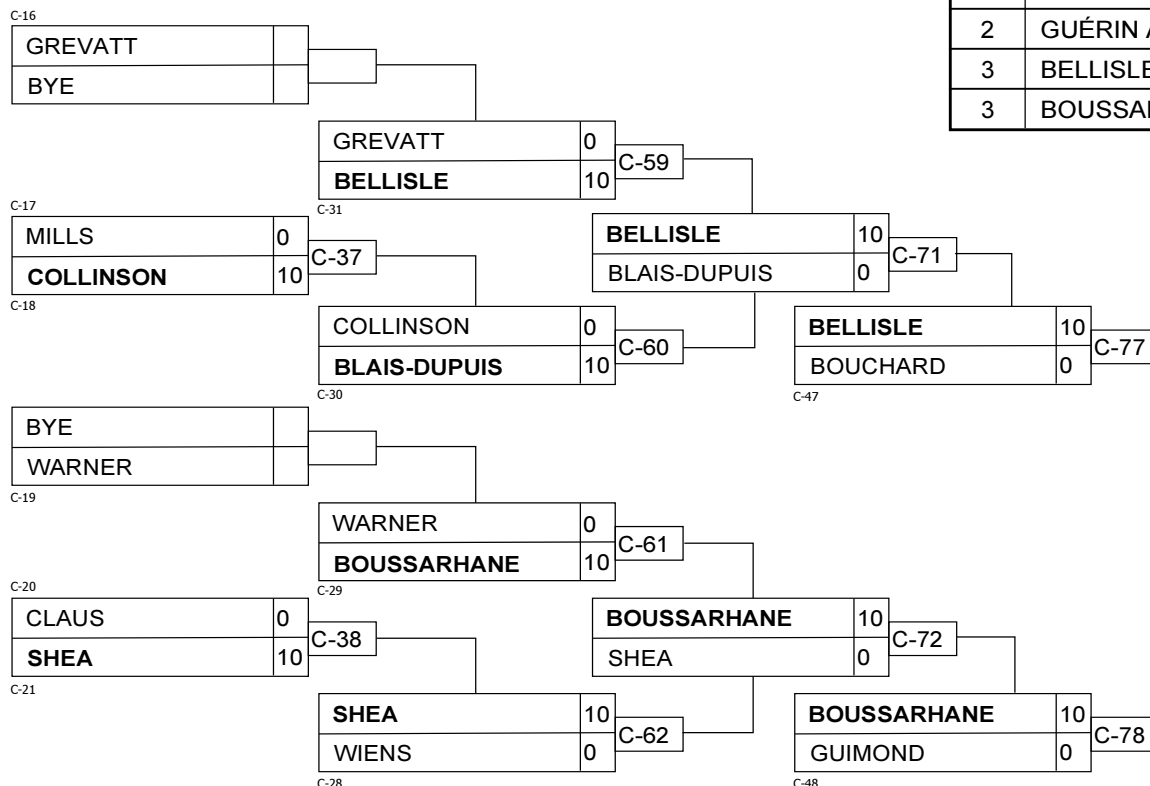

U16 F63

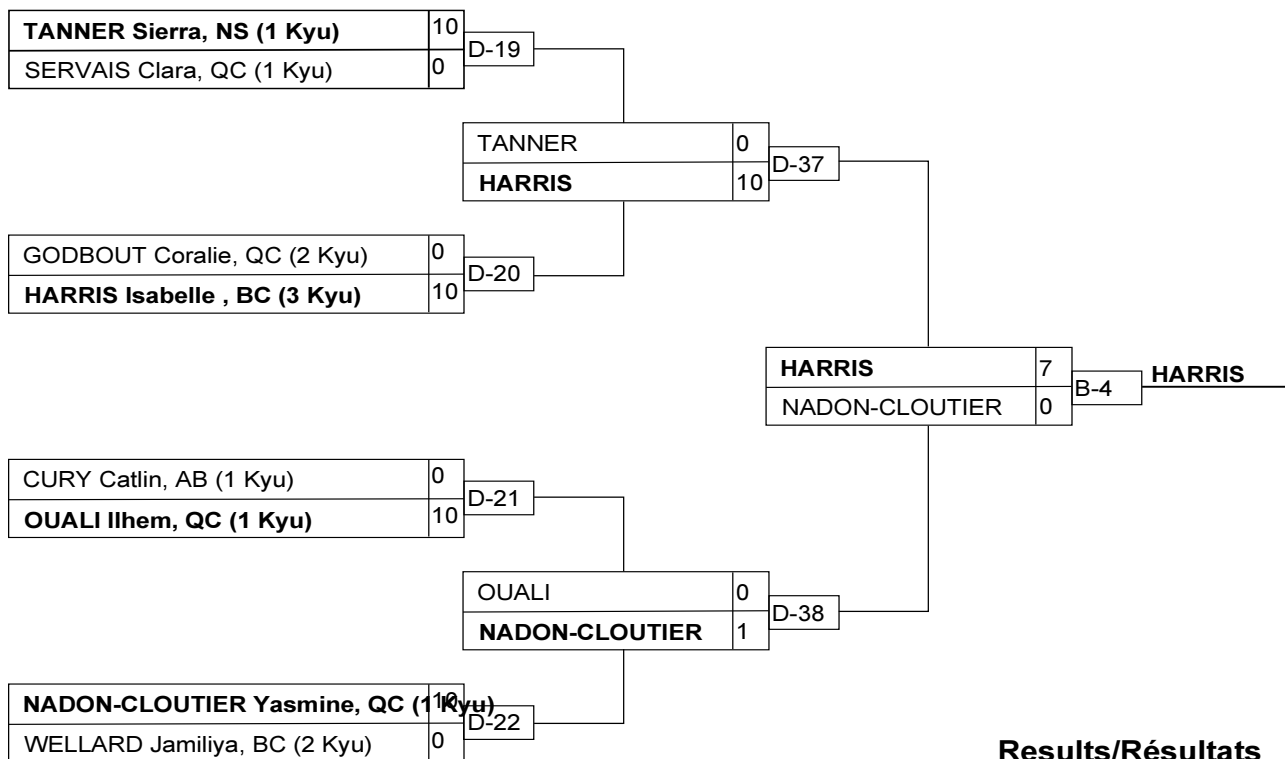

Results/Résultats

Pos	Name/Nom
1	HARRIS Isabelle , BC (3 Kyu)
2	NADON-CLOUTIER Yasmine, QC (1 Kyu)
3	TANNER Sierra, NS (1 Kyu)
3	OUALI Ilhem, QC (1 Kyu)

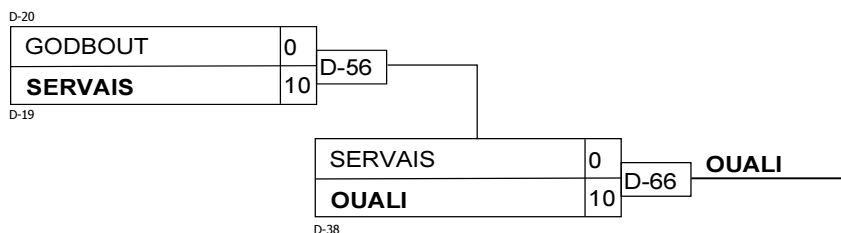
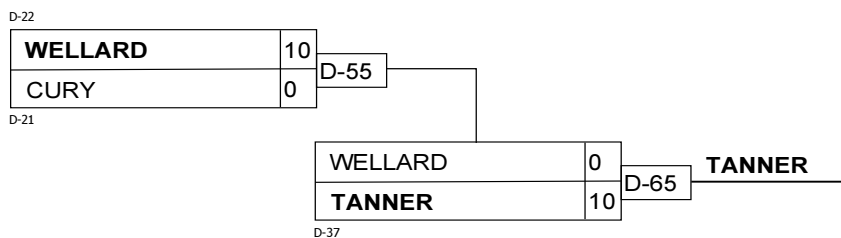

U16 F70

Competitors/Compétiteurs

#	Name/Nom	Grade	Club	1	2	3	4	5	W/G	Pts	Pos
1	BOOTH Brae	3 Kyu	BC	XX		10			1	10	4
2	ABBIGAIL McCullough	3 Kyu	NS	7	XX	10			2	17	3
3	LÉVESQUE Ariane	1 Kyu	QC			XX			0	0	5
4	SERGEEVA Julia	2 Kyu	AB	10	10	10	XX		3	30	2
5	MARTIN Maria	2 Kyu	SK	10	10	10	5	XX	4	35	1

Matches/Matches

Match	White/Blanc			Blue/Bleu	Res/Rés	Tim/Tmp	Code
C-22	SERGEEVA Julia	4	5	MARTIN Maria	0 - 5	3:00	YUK
C-23	BOOTH Brae	1	2	ABBIGAIL McCullough	0 - 7	3:00	WAZ
C-32	LÉVESQUE Ariane	3	4	SERGEEVA Julia	0 - 10	0:00	FUS
C-33	BOOTH Brae	1	5	MARTIN Maria	0 - 10	1:09	IPO
C-39	ABBIGAIL McCullough	2	3	LÉVESQUE Ariane	10 - 0	0:00	FUS
C-40	BOOTH Brae	1	4	SERGEEVA Julia	0 - 10	1:19	IPO
C-49	LÉVESQUE Ariane	3	5	MARTIN Maria	0 - 10	0:00	FUS
C-50	ABBIGAIL McCullough	2	4	SERGEEVA Julia	0 - 10	0:35	IPO
C-63	BOOTH Brae	1	3	LÉVESQUE Ariane	10 - 0	0:00	FUS
C-64	ABBIGAIL McCullough	2	5	MARTIN Maria	0 - 10	0:53	WIP

Results/Résultats

Pos	Name/Nom
1	MARTIN Maria, SK
2	SERGEEVA Julia, AB
3	ABBIGAIL McCullough, NS
4	BOOTH Brae, BC
5	LÉVESQUE Ariane, QC

U16 F70+

Competitors/Compétiteurs

#	Name/Nom	Grade	Club	1	2	3	W/G	Pts	Pos
1	ARCHAMBAULT Audrey	2 Kyu	QC	XX	7		1	7	3
2	SYNNOT Josianne	2 Kyu	QC		XX	10	1	10	1
3	WHABA Maram	1 Kyu	QC	10		XX	1	10	2

Matches/Matches

Match	White/Blanc			Blue/Bleu	Res/Rés	Tim/Tmp	Code
C-44	ARCHAMBAULT Audrey	1	2	SYNNOT Josianne	7 - 0	3:00	WAZ
C-54	ARCHAMBAULT Audrey	1	3	WHABA Maram	0 - 10	1:25	WIP
C-68	SYNNOT Josianne	2	3	WHABA Maram	10 - 0	1:59	WIP

Results/Résultats

Pos	Name/Nom
1	SYNNOT Josianne, QC
2	WHABA Maram, QC
3	ARCHAMBAULT Audrey, QC

U16 M38

Competitors/Compétiteurs

#	Name/Nom	Grade	Club	1	2	3	4	5	W/G	Pts	Pos
1	FRIZZELL Ioan	3 Kyu +	BC	XX					0	0	5
2	LACHANCE Claude-André	3 Kyu +	QC	10	XX	10	5		3	25	3
3	O'BRIEN Douglas	3 Kyu	AB	10		XX			1	10	4
4	JOE Maximus	3 Kyu	BC	10		10	XX	10	3	30	1
5	NORQUAY Graham	3 Kyu	BC	10	10	10		XX	3	30	2

Matches/Matches

Match	White/Blanc			Blue/Bleu	Res/Rés	Tim/Tmp	Code
A-28	JOE Maximus	4	5	NORQUAY Graham	10 - 0	1:19	IPO
A-29	FRIZZELL Ioan	1	2	LACHANCE Claude-André	0 - 10	2:00	WIP
A-39	O'BRIEN Douglas	3	4	JOE Maximus	0 - 10	1:25	IPO
A-40	FRIZZELL Ioan	1	5	NORQUAY Graham	0 - 10	0:24	WIP
A-47	LACHANCE Claude-André	2	3	O'BRIEN Douglas	10 - 0	0:41	IPO
A-48	FRIZZELL Ioan	1	4	JOE Maximus	0 - 10	1:18	WIP
A-59	O'BRIEN Douglas	3	5	NORQUAY Graham	0 - 10	0:11	IPO
A-60	LACHANCE Claude-André	2	4	JOE Maximus	5 - 0	3:00	YUK
A-67	FRIZZELL Ioan	1	3	O'BRIEN Douglas	0 - 10	1:42	WIP
A-68	LACHANCE Claude-André	2	5	NORQUAY Graham	0 - 10	1:41	WIP

Results/Résultats

Pos	Name/Nom
1	JOE Maximus, BC
2	NORQUAY Graham, BC
3	LACHANCE Claude-André, QC
4	O'BRIEN Douglas, AB
5	FRIZZELL Ioan, BC

U16 M42

Competitors/Compétiteurs A

#	Name/Nom	Grade	Club	1	2	3	4	W/G	Pts	Pos
1	ALLAIRE Éliot	3 Kyu	QC	XX				0	0	4
2	GARSON Max	2 Kyu	QC	10	XX		10	2	20	2
3	PROTEAU Benjamin	1 Kyu	QC	7	10	XX	7	3	24	1
4	MCKAY Justin	2 Kyu	SK	7			XX	1	7	3

Matches/Matchs A

Match	White/Blanc	Blue/Bleu	Res/Rés	Tim/Tmp	Code
C-41	ALLAIRE Éliot 1 2	GARSON Max	0 - 10	2:45	IPO
C-42	PROTEAU Benjamin 3 4	MCKAY Justin	7 - 0	3:14	GSW
C-51	ALLAIRE Éliot 1 3	PROTEAU Benjamin	0 - 7	3:00	WAZ
C-52	GARSON Max 2 4	MCKAY Justin	10 - 0	2:45	IPO
C-65	ALLAIRE Éliot 1 4	MCKAY Justin	0 - 7	3:00	WAZ
C-66	GARSON Max 2 3	PROTEAU Benjamin	0 - 10	3:00	IPO

Competitors/Compétiteurs B

#	Name/Nom	Grade	Club	5	6	7	W/G	Pts	Pos
5	HANEARIN-BALCZER Jarrett	3 Kyu	AB	XX			0	0	3
6	BLACKIÈRE Arno	1 Kyu	QC	10	XX	1	2	11	1
7	PAQUET Simon	1 Kyu	QC	10		XX	1	10	2

Matches/Matchs B

Match	White/Blanc	Blue/Bleu	Res/Rés	Tim/Tmp	Code
C-43	HANEARIN-BALCZER Jarrett 5 6	BLACKIÈRE Arno	0 - 10	2:32	WIP
C-53	HANEARIN-BALCZER Jarrett 5 7	PAQUET Simon	0 - 10	0:11	IPO
C-67	BLACKIÈRE Arno 6 7	PAQUET Simon	1 - 0	3:00	YUS

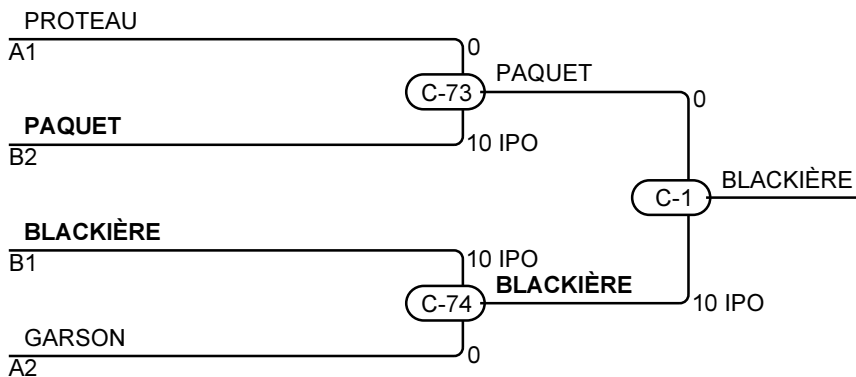

Results/Résultats

Pos	Name/Nom
1	BLACKIÈRE Arno, QC
2	PAQUET Simon, QC
3	PROTEAU Benjamin, QC
3	GARSON Max, QC

U16 M46

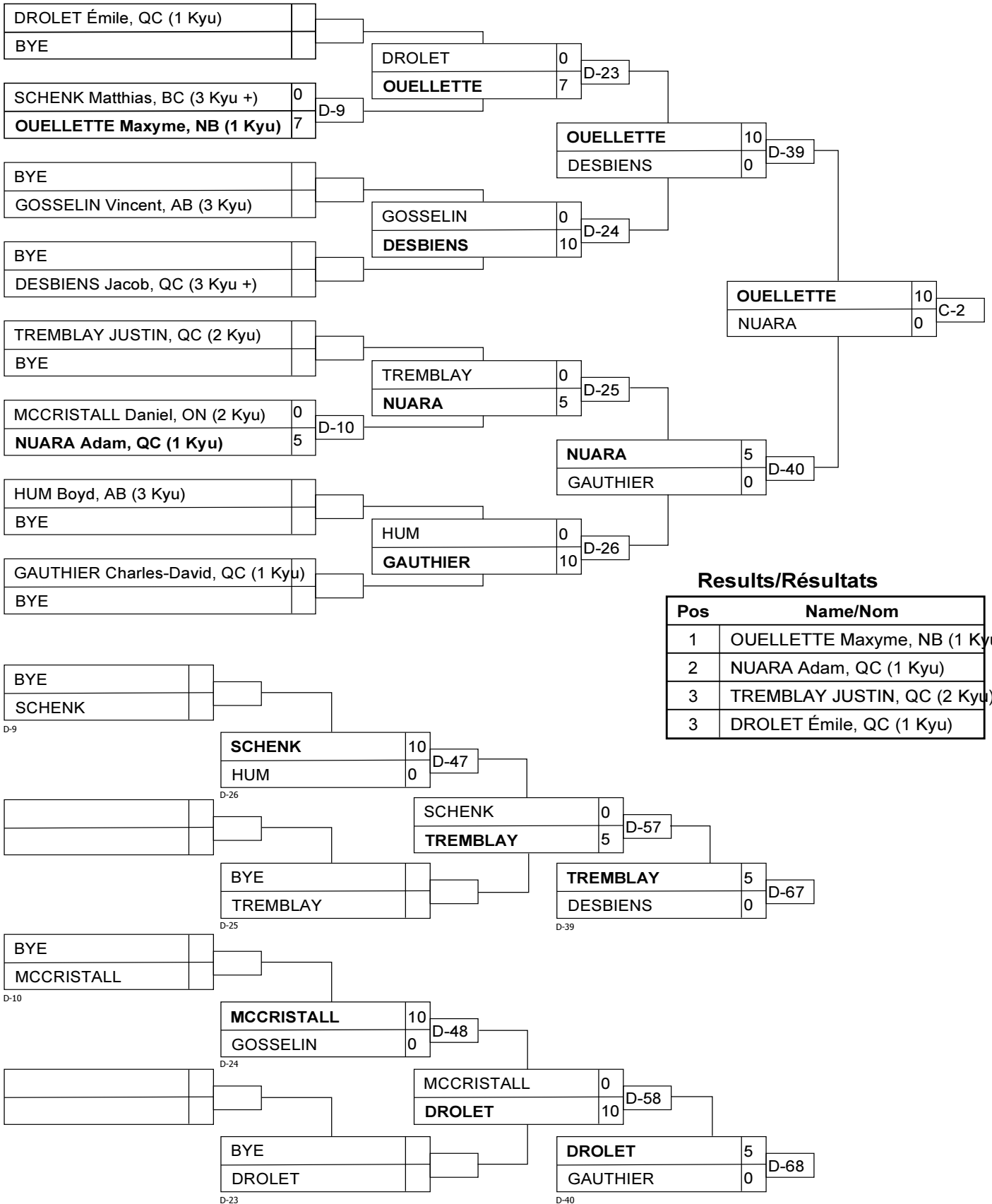

U16 M50

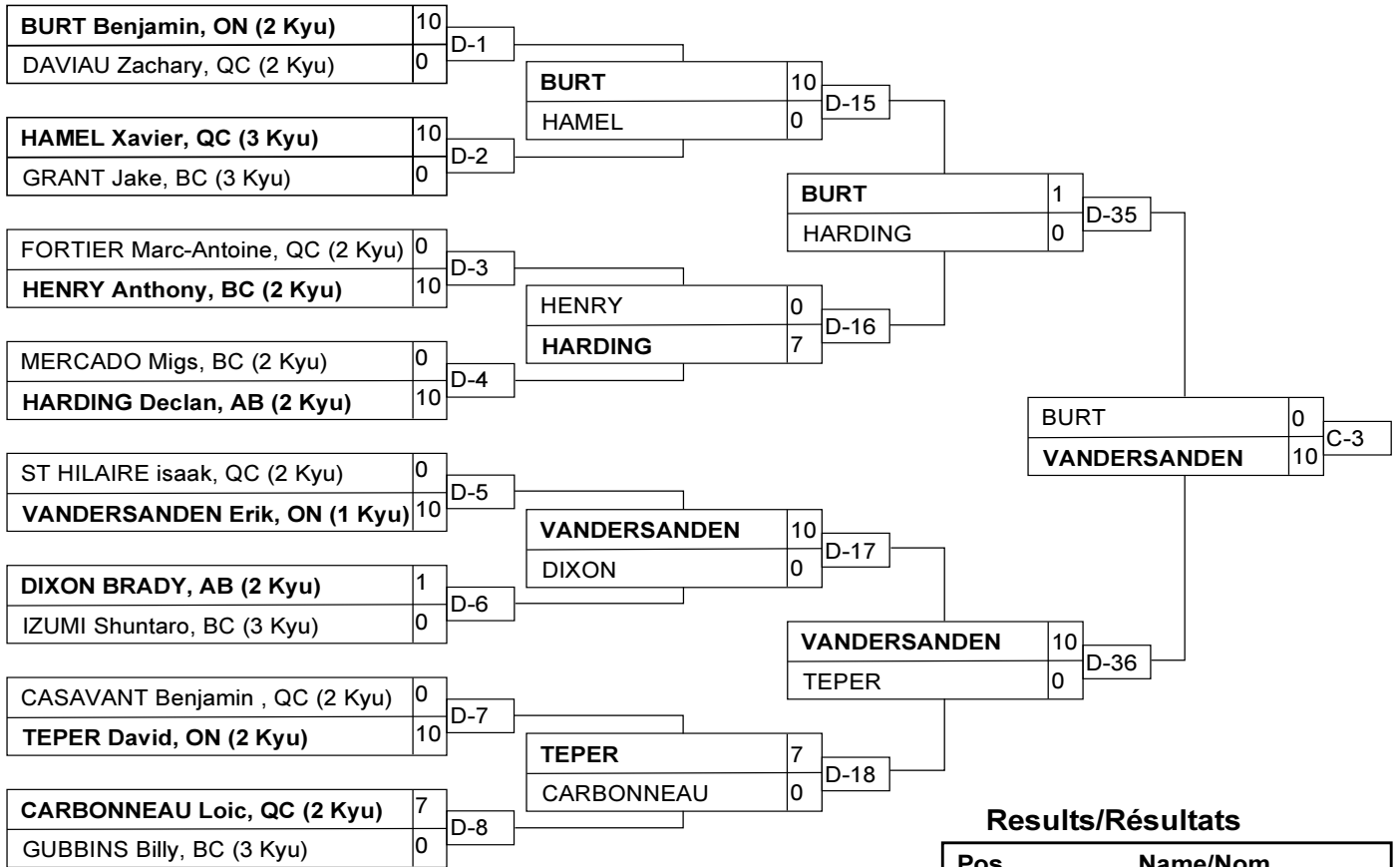

Results/Résultats

Pos	Name/Nom
1	VANDERSANDEN Erik, ON (1 Kyu)
2	BURT Benjamin, ON (2 Kyu)
3	DIXON BRADY, AB (2 Kyu)
3	TEPER David, ON (2 Kyu)

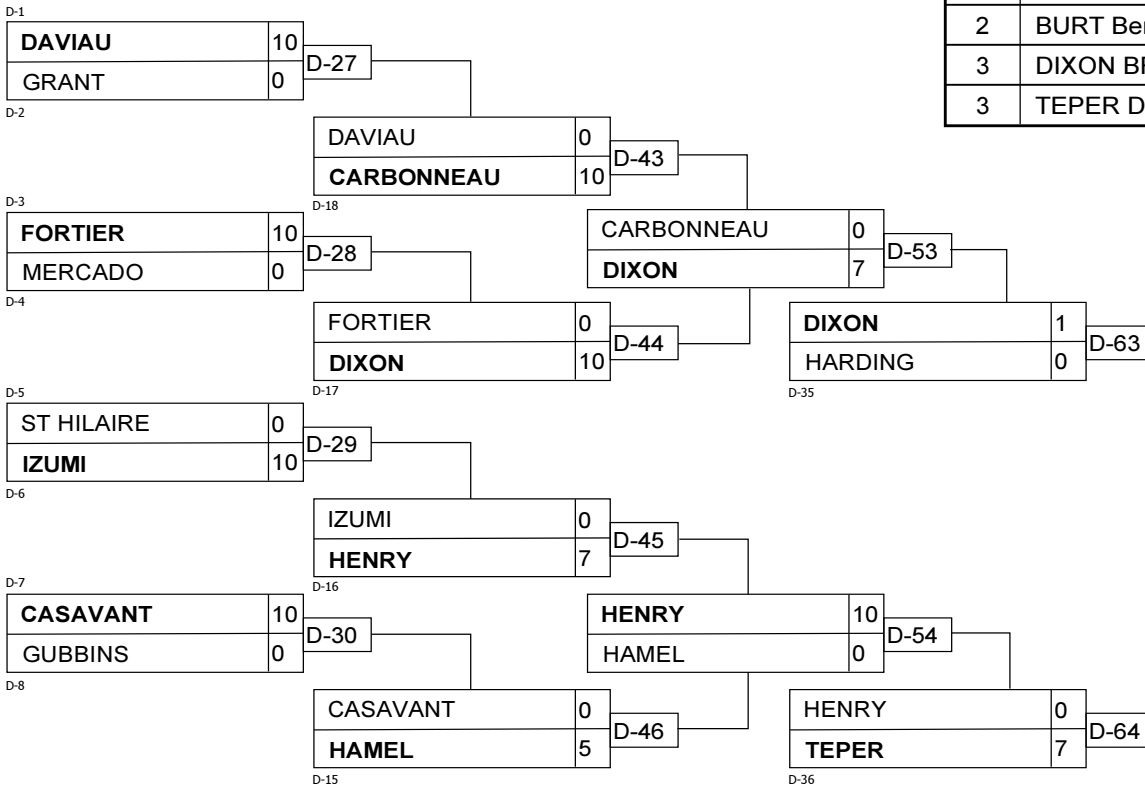

U16 M55

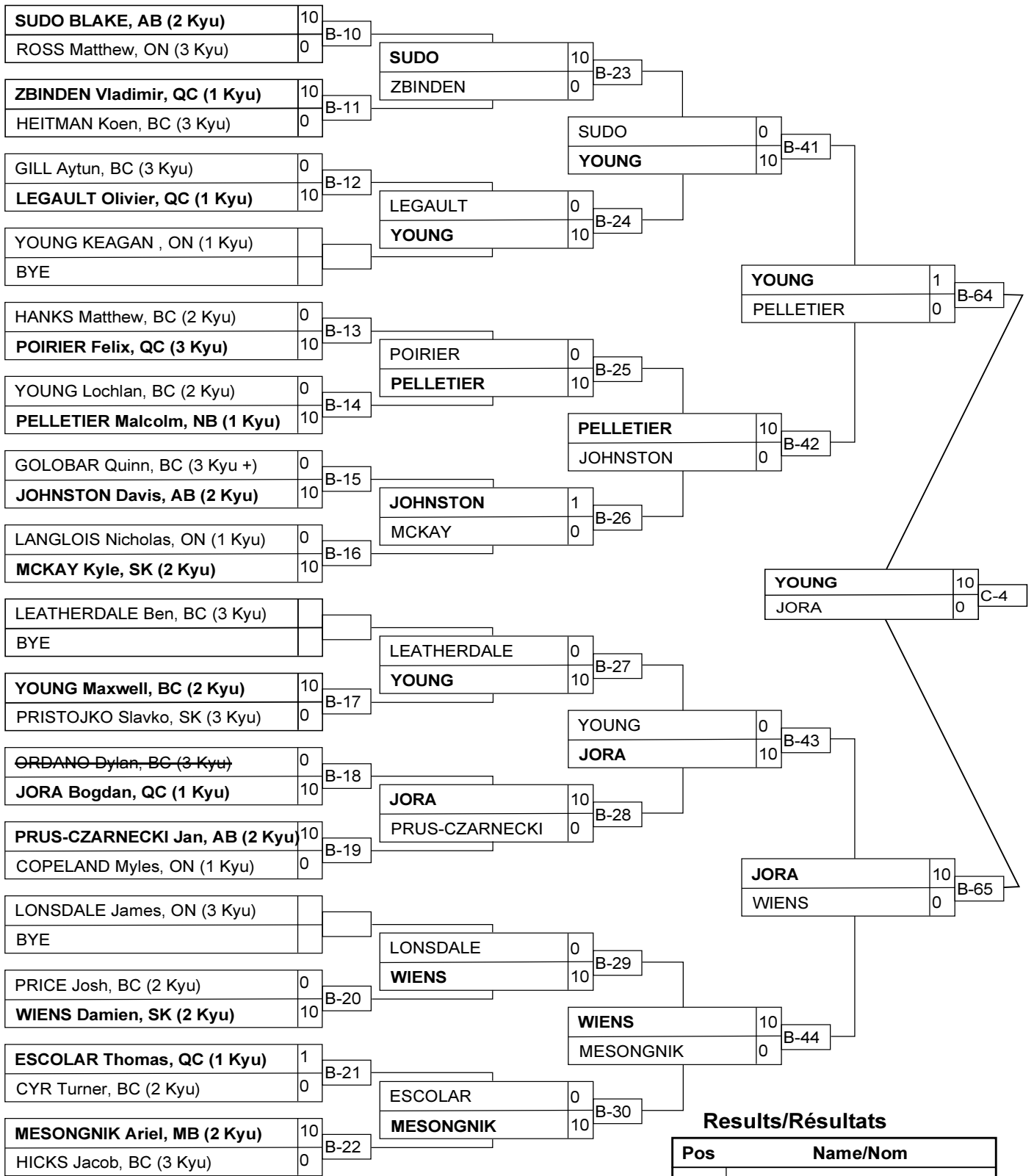

Results/Résultats

Pos	Name/Nom
1	YOUNG KEAGAN , ON (1 Kyu)
2	JORA Bogdan, QC (1 Kyu)
3	PELLETIER Malcolm, NB (1 Kyu)
3	WIENS Damien, SK (2 Kyu)

U16 M55

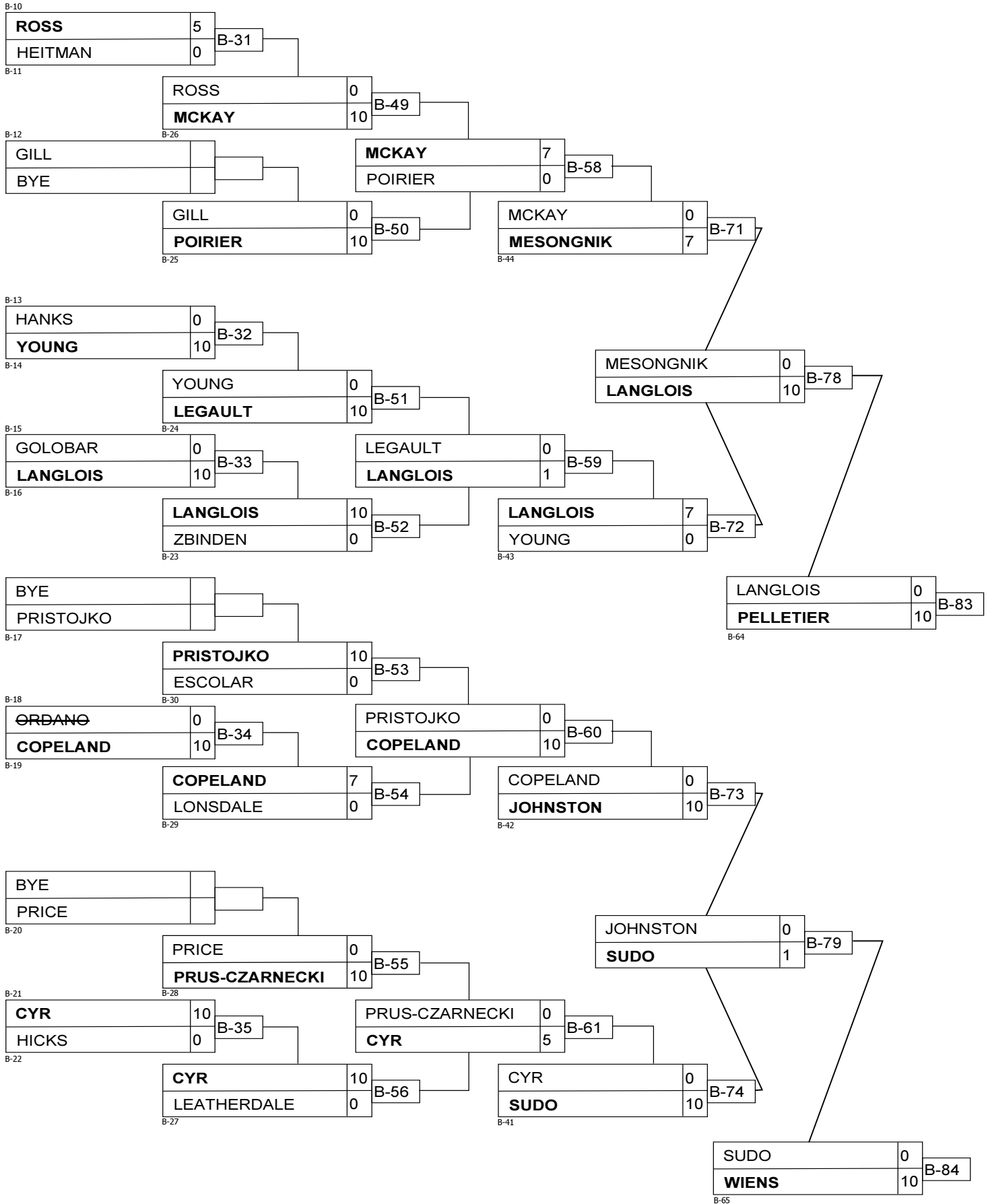

U16 M60

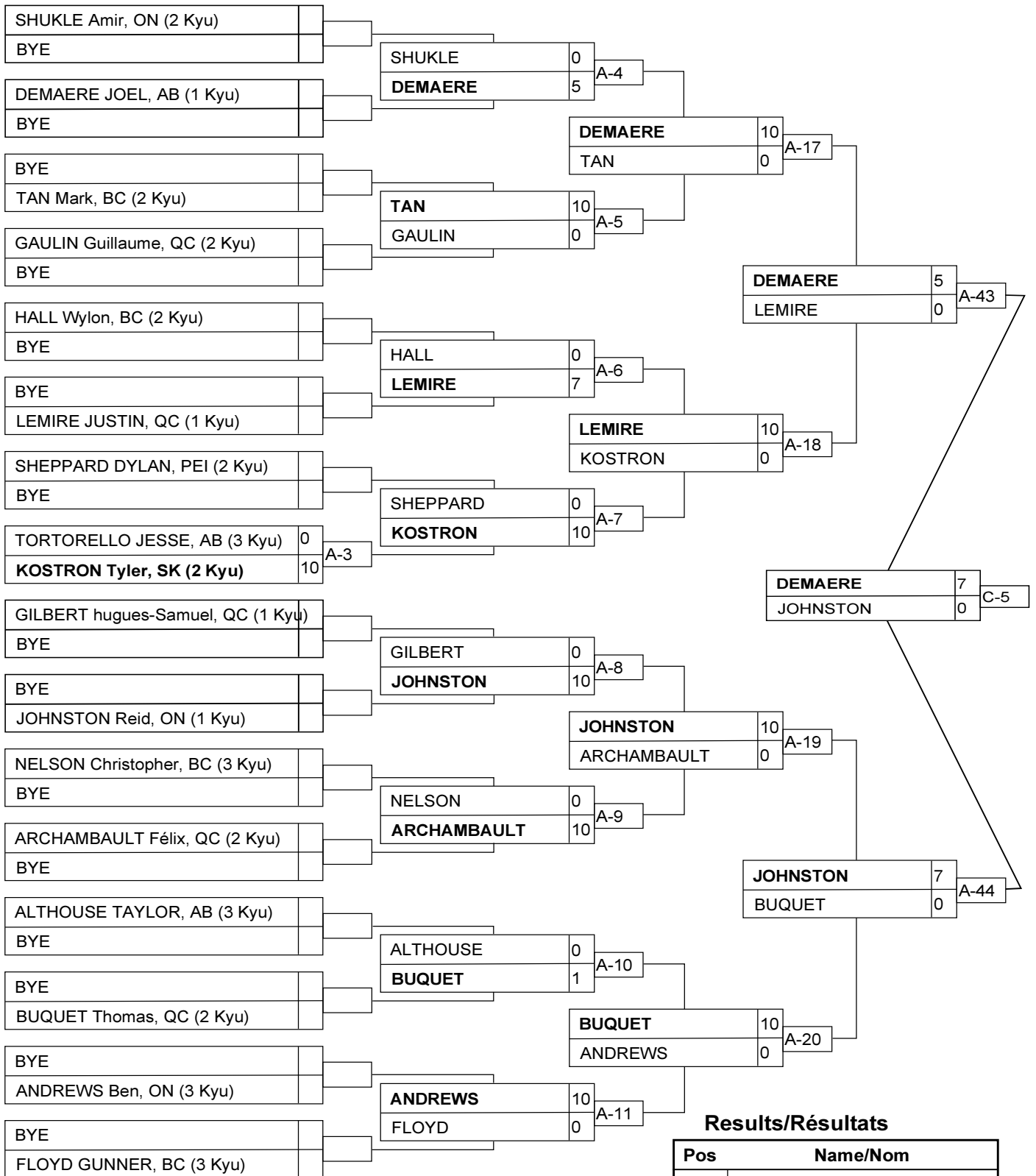

U16 M60

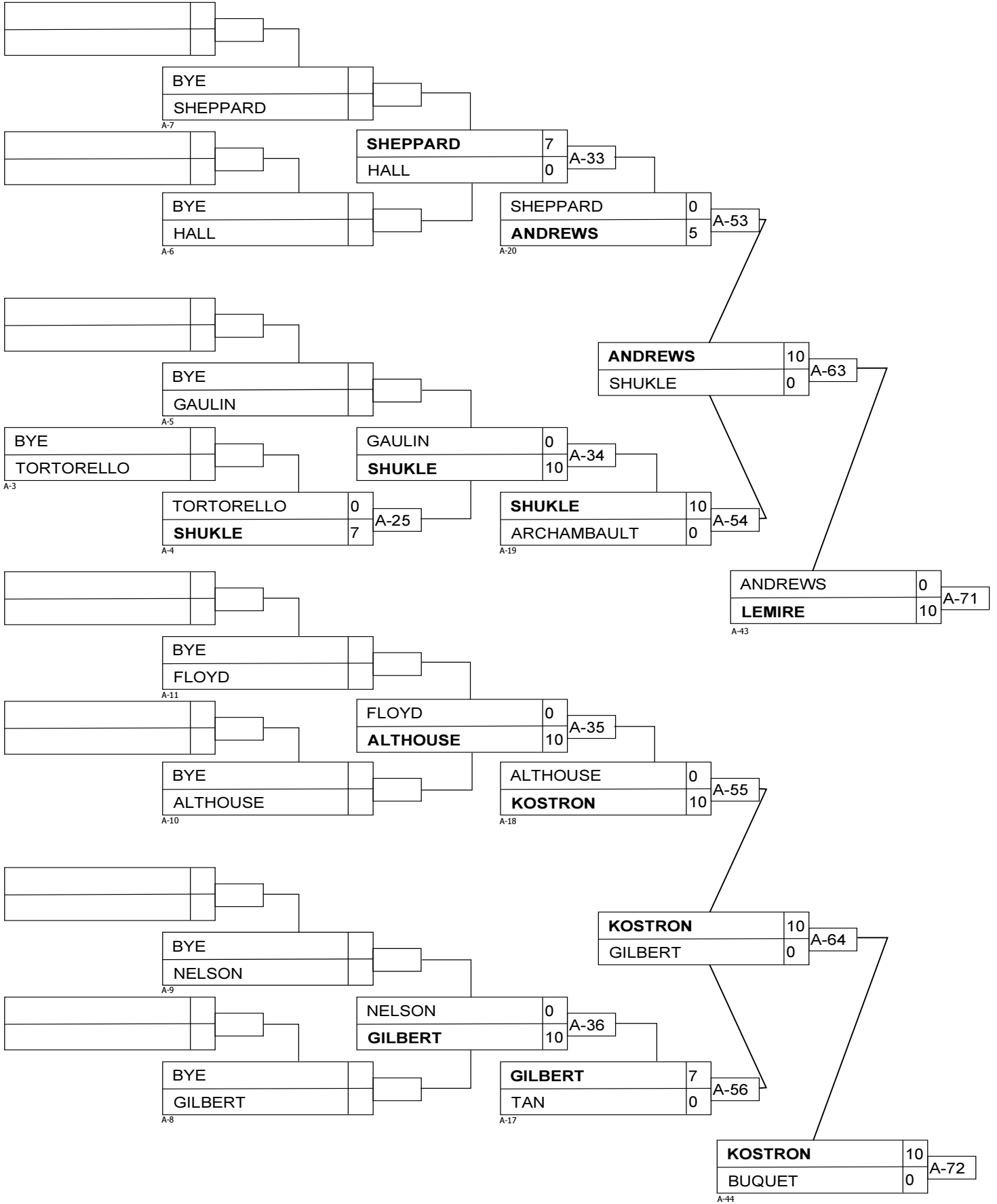

U16 M66

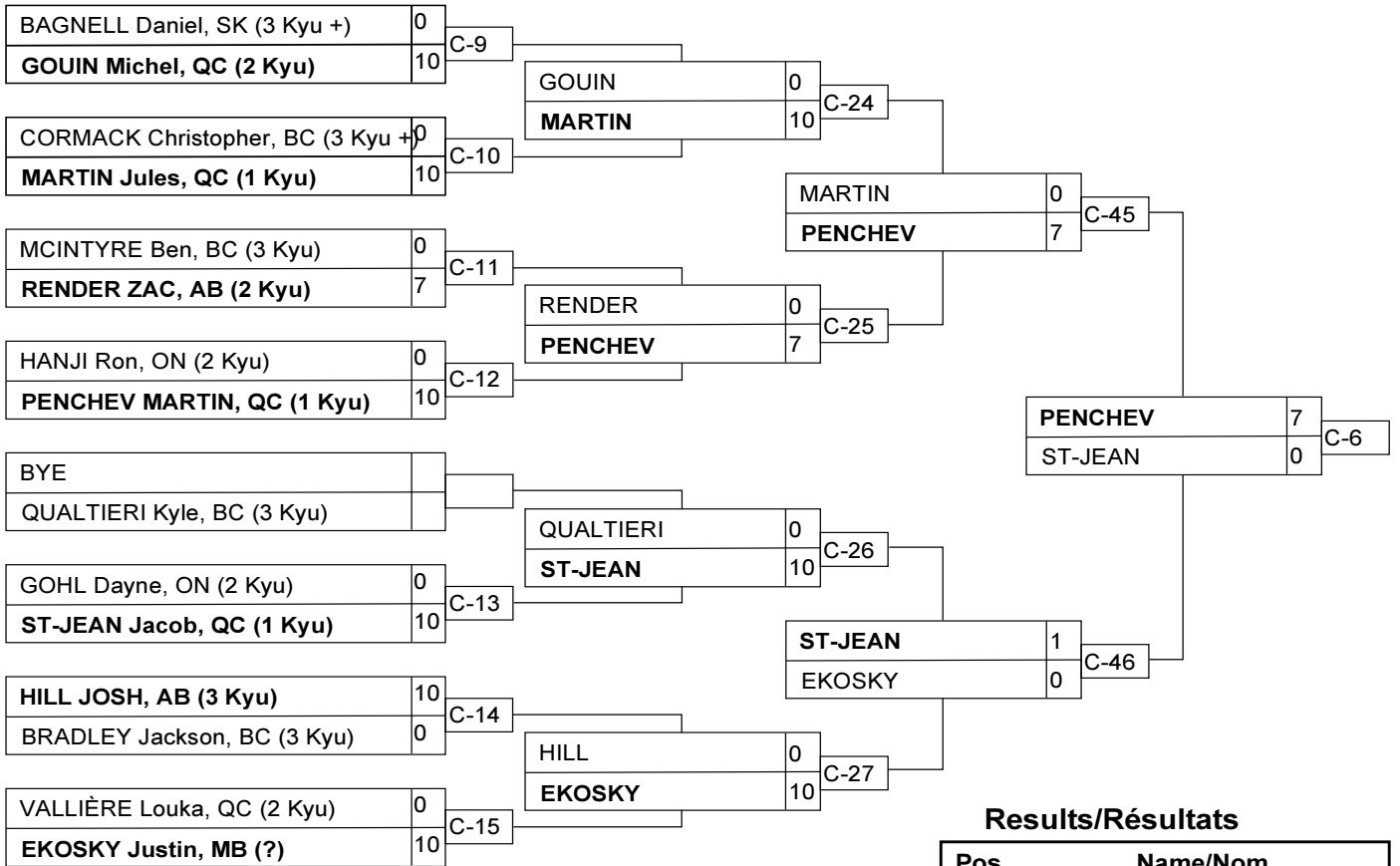

Results/Résultats

Pos	Name/Nom
1	PENCHEV MARTIN, QC (1 Kyu)
2	ST-JEAN Jacob, QC (1 Kyu)
3	MARTIN Jules, QC (1 Kyu)
3	EKOSKY Justin, MB (?)

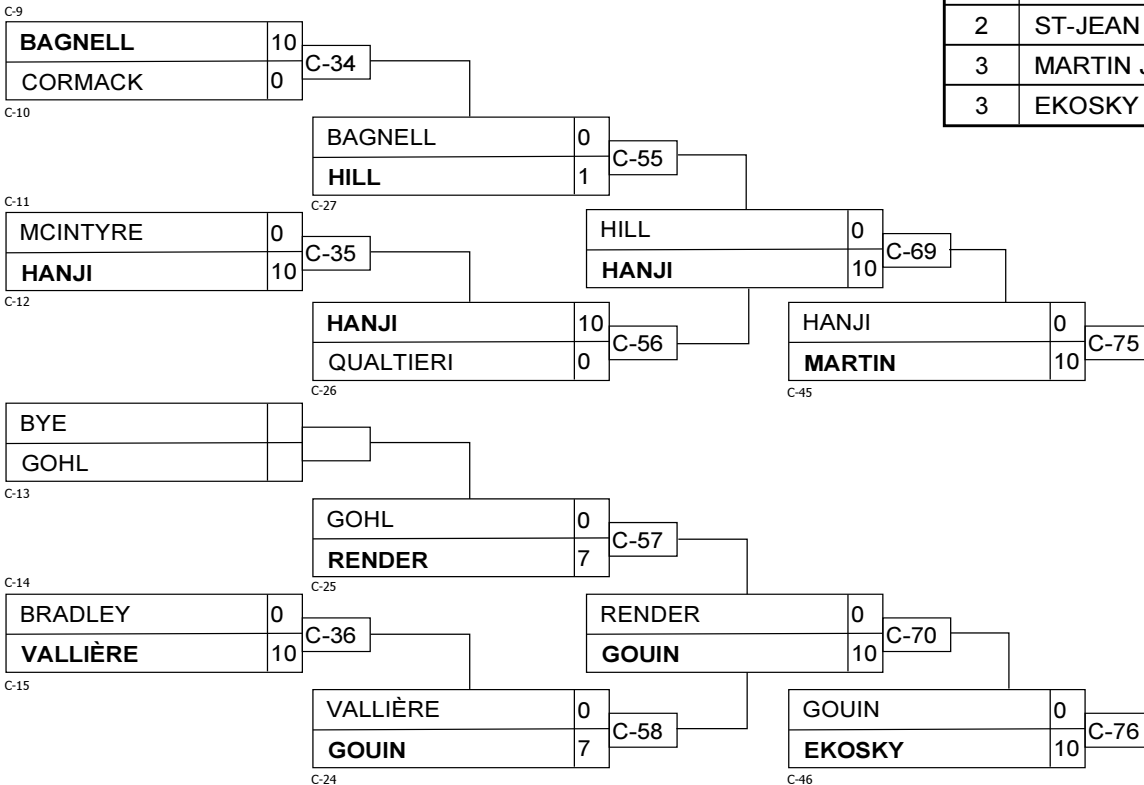

U16 M73

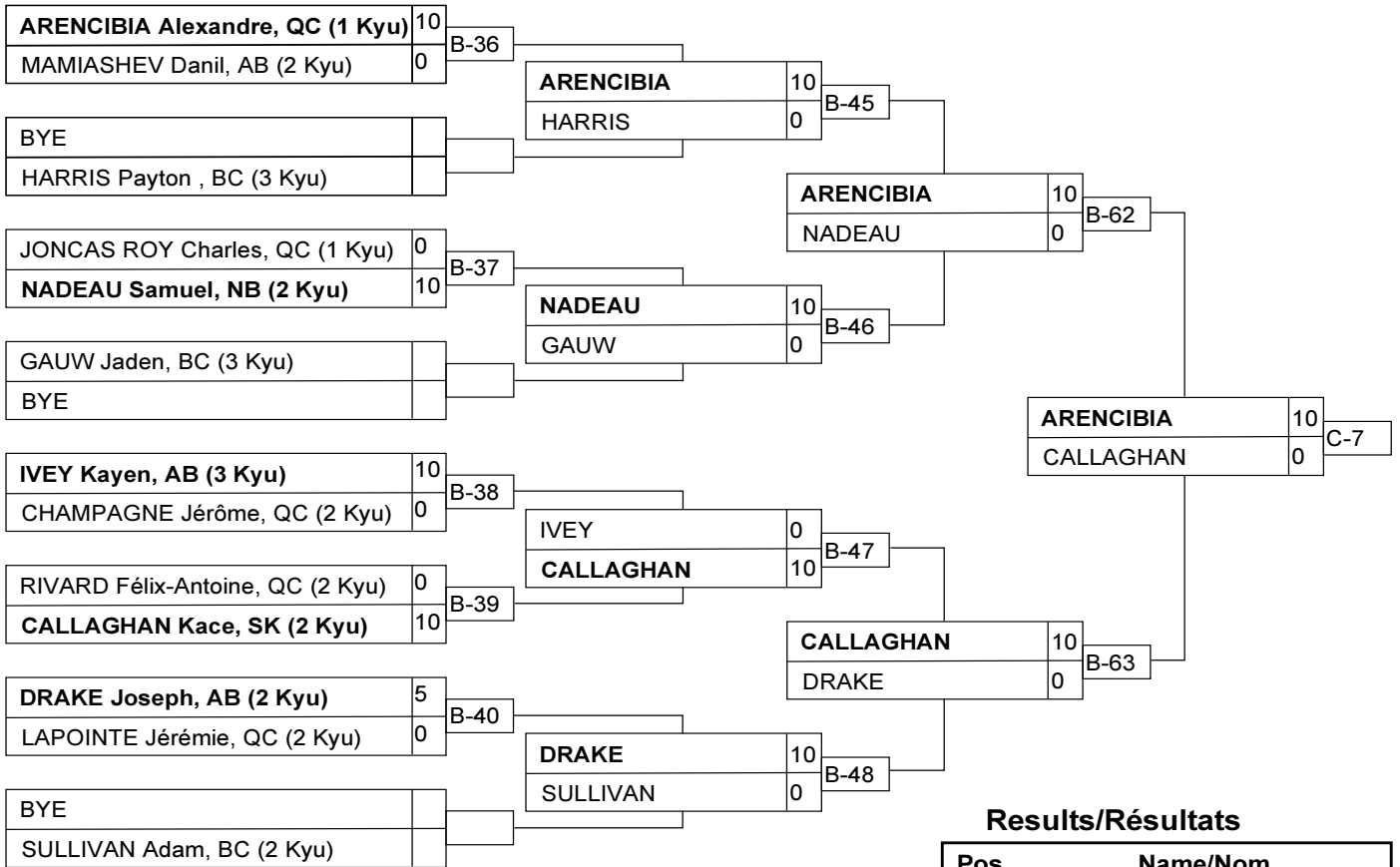

Results/Résultats

Pos	Name/Nom
1	ARENCIBIA Alexandre, QC (1 Kyu)
2	CALLAGHAN Kace, SK (2 Kyu)
3	MAMIASHEV Danil, AB (2 Kyu)
3	LAPOINTE Jérémie, QC (2 Kyu)

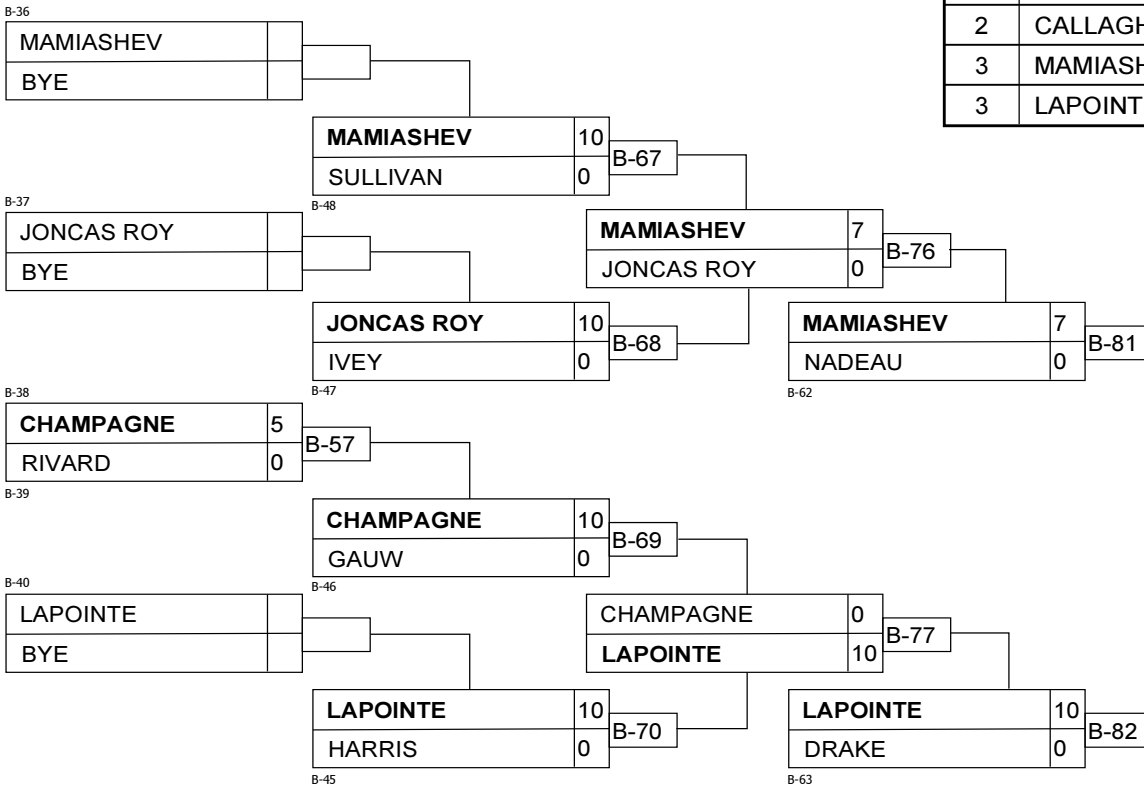

U16 M73+

Competitors/Compétiteurs A

#	Name/Nom	Grade	Club	1	2	3	W/G	Pts	Pos
1	NASH SEBASTIAN	2 Kyu	PEI	XX			0	0	3
2	COUTU XAVIER	1 Kyu	QC	5	XX		1	5	2
3	BECKER Rayleigh	1 Kyu	ON	10	5	XX	2	15	1

Matches/Matchs A

Match	White/Blanc	Blue/Bleu	Res/Rés	Tim/Tmp	Code
D-31	NASH SEBASTIAN 1 2	COUTU XAVIER	0 - 5	3:00	YUK
D-41	NASH SEBASTIAN 1 3	BECKER Rayleigh	0 - 10	2:47	WIP
D-49	COUTU XAVIER 2 3	BECKER Rayleigh	0 - 5	3:00	YUK

Competitors/Compétiteurs B

#	Name/Nom	Grade	Club	4	5	6	W/G	Pts	Pos
4	LEMIEUX Gabriel	2 Kyu	QC	XX	10		1	10	2
5	COBBE-HOGGAN Ethan	3 Kyu	AB		XX		0	0	3
6	RYDER Ian	1 Kyu	BC	10	10	XX	2	20	1

Matches/Matchs B

Match	White/Blanc	Blue/Bleu	Res/Rés	Tim/Tmp	Code
D-32	LEMIEUX Gabriel 4 5	COBBE-HOGGAN Ethan	10 - 0	2:39	HAN
D-42	LEMIEUX Gabriel 4 6	RYDER Ian	0 - 10	0:55	IPO
D-50	COBBE-HOGGAN Ethan 5 6	RYDER Ian	0 - 10	0:48	WIP

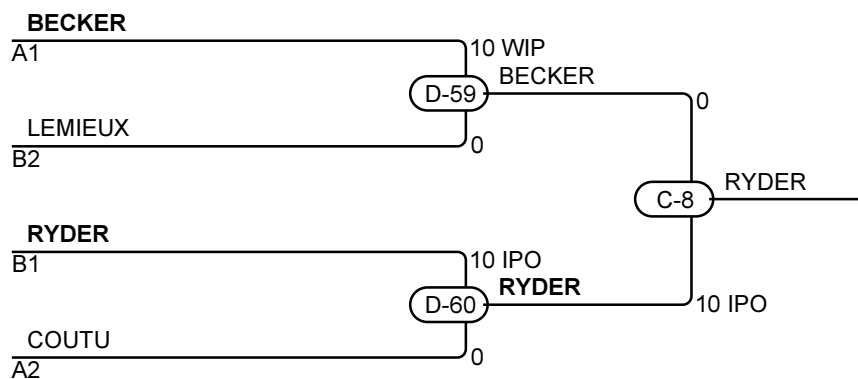

Results/Résultats

Pos	Name/Nom
1	RYDER Ian , BC
2	BECKER Rayleigh, ON
3	LEMIEUX Gabriel, QC
3	COUTU XAVIER, QC

U21 F48

Competitors/Compétiteurs

#	Name/Nom	Grade	Club	1	2	3	W/G	Pts	Pos
1	RINCON Carolina	1 Kyu	ON	XX	10		1	10	2
2	PIGNATELLI Serena	2 Kyu	BC		XX		0	0	3
3	ROY Léa	1 Kyu	QC	7	7	XX	2	14	1

Matches/Matches

Match	White/Blanc			Blue/Bleu	Res/Rés	Tim/Tmp	Code
D-83	RINCON Carolina	1	2	PIGNATELLI Serena	10 - 0	3:13	WIP
D-92	RINCON Carolina	1	3	ROY Léa	0 - 7	4:00	WAZ
D-101	PIGNATELLI Serena	2	3	ROY Léa	0 - 7	4:00	WAZ

Results/Résultats

Pos	Name/Nom
1	ROY Léa , QC
2	RINCON Carolina, ON
3	PIGNATELLI Serena, BC

U21 F52

Competitors/Compétiteurs

#	Name/Nom	Grade	Club	1	2	3	W/G	Pts	Pos
1	RUSSELL Lisa	1 Kyu	BC	XX			0	0	3
2	THIFFAULT Laurence	Shodan	QC	5	XX		1	5	2
3	BESSION Marie	Shodan	QC	10	10	XX	2	20	1

Matches/Matches

Match	White/Blanc			Blue/Bleu	Res/Rés	Tim/Tmp	Code
D-84	RUSSELL Lisa	1	2	THIFFAULT Laurence	0 - 5	4:00	YUK
D-93	RUSSELL Lisa	1	3	BESSION Marie	0 - 10	0:42	IPO
D-102	THIFFAULT Laurence	2	3	BESSION Marie	0 - 10	1:03	IPO

Results/Résultats

Pos	Name/Nom
1	BESSION Marie, QC
2	THIFFAULT Laurence, QC
3	RUSSELL Lisa, BC

U21 F57

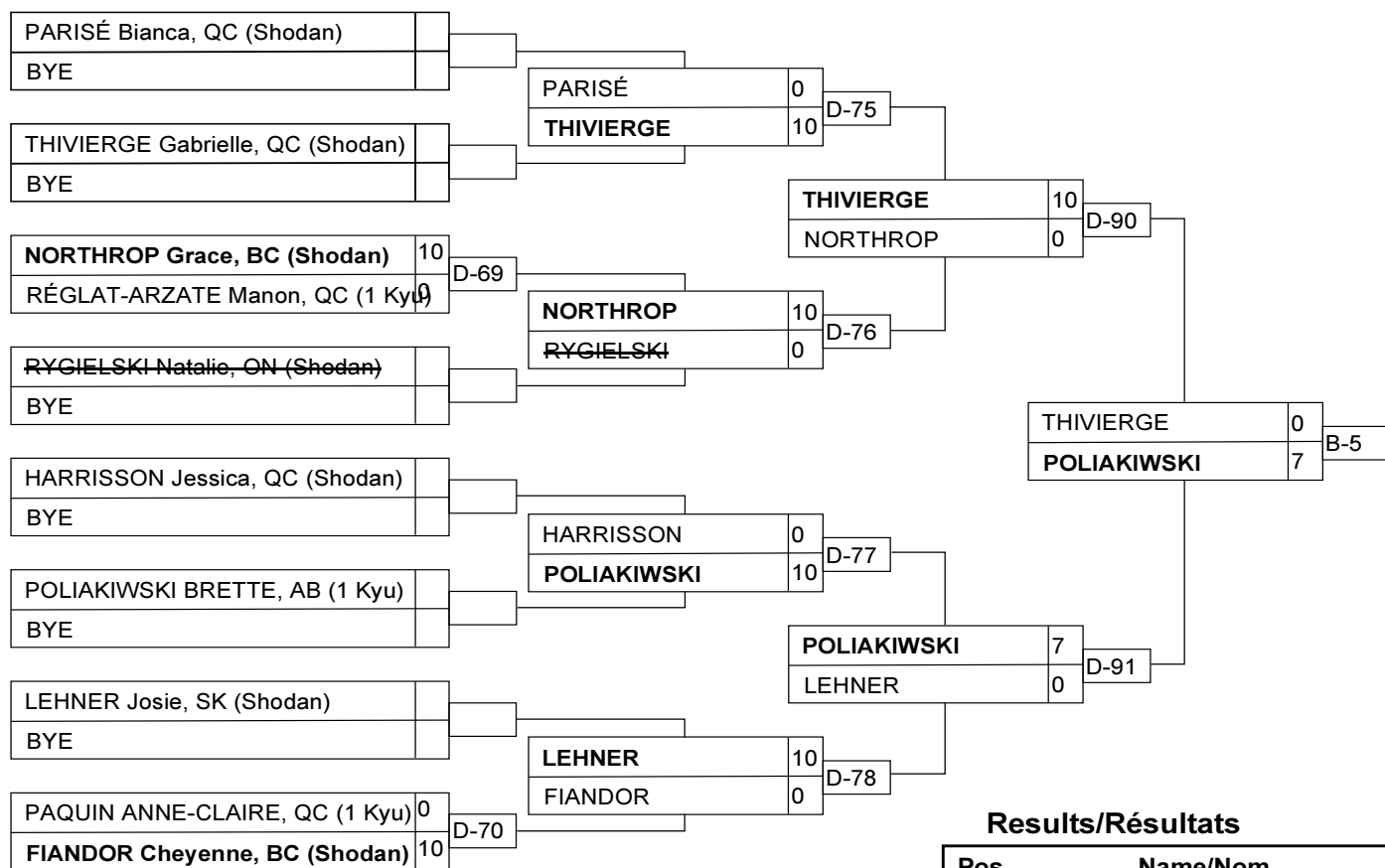

Results/Résultats

Pos	Name/Nom
1	POLIAKIWSKI BRETTE, AB (1 Kyu)
2	THIVIERGE Gabrielle, QC (Shodan)
3	NORTHROP Grace, BC (Shodan)
3	LEHNER Josie, SK (Shodan)

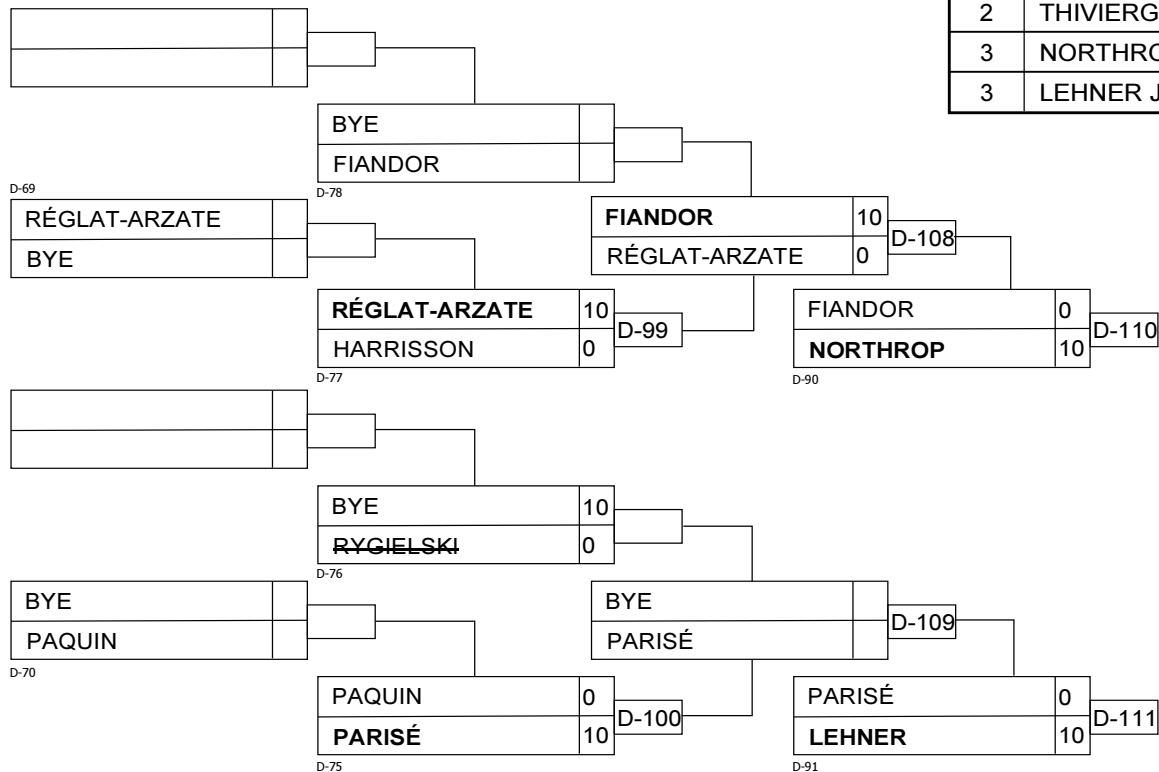

U21 F63

Competitors/Compétiteurs

#	Name/Nom	Grade	Club	1	2	3	4	5	W/G	Pts	Pos
1	DE GRANDMAISON Audrey	Shodan	QC	XX		10	10		2	20	3
2	MICHEL Janika	1 Kyu	QC	1	XX	10	10	10	4	31	1
3	KAEGI Alisha	Shodan	MB			XX	5	10	2	15	4
4	DUQUETTE-PLANTE Marion	1 Kyu	QC				XX		0	0	5
5	MONTGOMERY Taryn	1 Kyu	SK	10			10	XX	2	20	2

Matches/Matches

Match	White/Blanc			Blue/Bleu	Res/Rés	Tim/Tmp	Code
D-73	DUQUETTE-PLANTE Marion	4	5	MONTGOMERY Taryn	0 - 10	2:31	IPO
D-74	DE GRANDMAISON Audrey	1	2	MICHEL Janika	0 - 1	4:00	YUS
D-81	KAEGI Alisha	3	4	DUQUETTE-PLANTE Marion	5 - 0	4:00	YUK
D-82	DE GRANDMAISON Audrey	1	5	MONTGOMERY Taryn	0 - 10	1:19	IPO
D-88	MICHEL Janika	2	3	KAEGI Alisha	10 - 0	0:34	WIP
D-89	DE GRANDMAISON Audrey	1	4	DUQUETTE-PLANTE Marion	10 - 0	1:51	IPO
D-97	KAEGI Alisha	3	5	MONTGOMERY Taryn	10 - 0	0:36	WIP
D-98	MICHEL Janika	2	4	DUQUETTE-PLANTE Marion	10 - 0	0:53	IPO
D-106	DE GRANDMAISON Audrey	1	3	KAEGI Alisha	10 - 0	2:21	WIP
D-107	MICHEL Janika	2	5	MONTGOMERY Taryn	10 - 0	2:08	IPO

Results/Résultats

Pos	Name/Nom
1	MICHEL Janika, QC
2	MONTGOMERY Taryn, SK
3	DE GRANDMAISON Audrey, QC
4	KAEGI Alisha, MB
5	DUQUETTE-PLANTE Marion, QC

U21 F70

Competitors/Compétiteurs

#	Name/Nom	Grade	Club	1	2	3	4	5	W/G	Pts	Pos
1	TROTTER KEIRA	1 Kyu	AB	XX		1	10		2	11	3
2	COPELAND Allayah	1 Kyu	ON	5	XX	7	10		3	22	2
3	POIRIER Audrey	Shodan	QC			XX	10		1	10	4
4	CHIRILA Maria-Carla	1 Kyu	QC				XX		0	0	5
5	PORTUONDO-ISASI Adriana	Shodan	QC	10	10	10	10	XX	4	40	1

Matches/Matches

Match	White/Blanc			Blue/Bleu	Res/Rés	Tim/Tmp	Code
D-71	CHIRILA Maria-Carla	4	5	PORTUONDO-ISASI Adriana	0 - 10	0:00	FUS
D-72	TROTTER KEIRA	1	2	COPELAND Allayah	0 - 5	4:00	YUK
D-79	POIRIER Audrey	3	4	CHIRILA Maria-Carla	10 - 0	0:00	FUS
D-80	TROTTER KEIRA	1	5	PORTUONDO-ISASI Adriana	0 - 10	2:49	WIP
D-85	COPELAND Allayah	2	3	POIRIER Audrey	7 - 0	4:00	WAZ
D-86	TROTTER KEIRA	1	4	CHIRILA Maria-Carla	10 - 0	0:00	FUS
D-94	POIRIER Audrey	3	5	PORTUONDO-ISASI Adriana	0 - 10	1:04	WIP
D-95	COPELAND Allayah	2	4	CHIRILA Maria-Carla	10 - 0	0:00	FUS
D-103	TROTTER KEIRA	1	3	POIRIER Audrey	1 - 0	4:00	YUS
D-104	COPELAND Allayah	2	5	PORTUONDO-ISASI Adriana	0 - 10	4:00	WIP

Results/Résultats

Pos	Name/Nom
1	PORTUONDO-ISASI Adriana, QC
2	COPELAND Allayah, ON
3	TROTTER KEIRA, AB
4	POIRIER Audrey, QC
5	CHIRILA Maria-Carla, QC

U21 F78

Competitors/Compétiteurs

#	Name/Nom	Grade	Club	1	2	3	W/G	Pts	Pos
1	GRONEN Shianne	2 Kyu	BC	XX	10	10	2	20	1
2	HANKS Megan	Shodan	BC		XX		0	0	3
3	COULOMBE Mina	Shodan	QC		10	XX	1	10	2

Matches/Matches

Match	White/Blanc			Blue/Bleu	Res/Rés	Tim/Tmp	Code
D-87	GRONEN Shianne	1	2	HANKS Megan	10 - 0	2:17	HAN
D-96	GRONEN Shianne	1	3	COULOMBE Mina	10 - 0	0:18	HAN
D-105	HANKS Megan	2	3	COULOMBE Mina	0 - 10	4:00	IPO

Results/Résultats

Pos	Name/Nom
1	GRONEN Shianne, BC
2	COULOMBE Mina, QC
3	HANKS Megan, BC

U21 M55

Competitors/Compétiteurs

#	Name/Nom	Grade	Club	1	2	3	4	W/G	Pts	Pos
1	PARET Shaïm	1 Kyu	QC	XX		10		1	10	3
2	ALKHATIB ISMAIL	1 Kyu	QC	7	XX	10	7	3	24	1
3	NINALGA Vincent	1 Kyu	BC			XX		0	0	4
4	MACFADYEN Torin	Shodan	ON	10		10	XX	2	20	2

Matches/Matches

Match	White/Blanc			Blue/Bleu	Res/Rés	Tim/Tmp	Code
A-90	PARET Shaïm	1	2	ALKHATIB ISMAIL	0 - 7	4:00	WAZ
A-91	NINALGA Vincent	3	4	MACFADYEN Torin	0 - 10	1:36	WIP
A-96	PARET Shaïm	1	3	NINALGA Vincent	10 - 0	1:43	HAN
A-97	ALKHATIB ISMAIL	2	4	MACFADYEN Torin	7 - 0	4:00	WAZ
A-104	PARET Shaïm	1	4	MACFADYEN Torin	0 - 10	1:57	IPO
A-105	ALKHATIB ISMAIL	2	3	NINALGA Vincent	10 - 0	1:50	IPO

Results/Résultats

Pos	Name/Nom
1	ALKHATIB ISMAIL, QC
2	MACFADYEN Torin, ON
3	PARET Shaïm, QC
4	NINALGA Vincent, BC

U21 M60

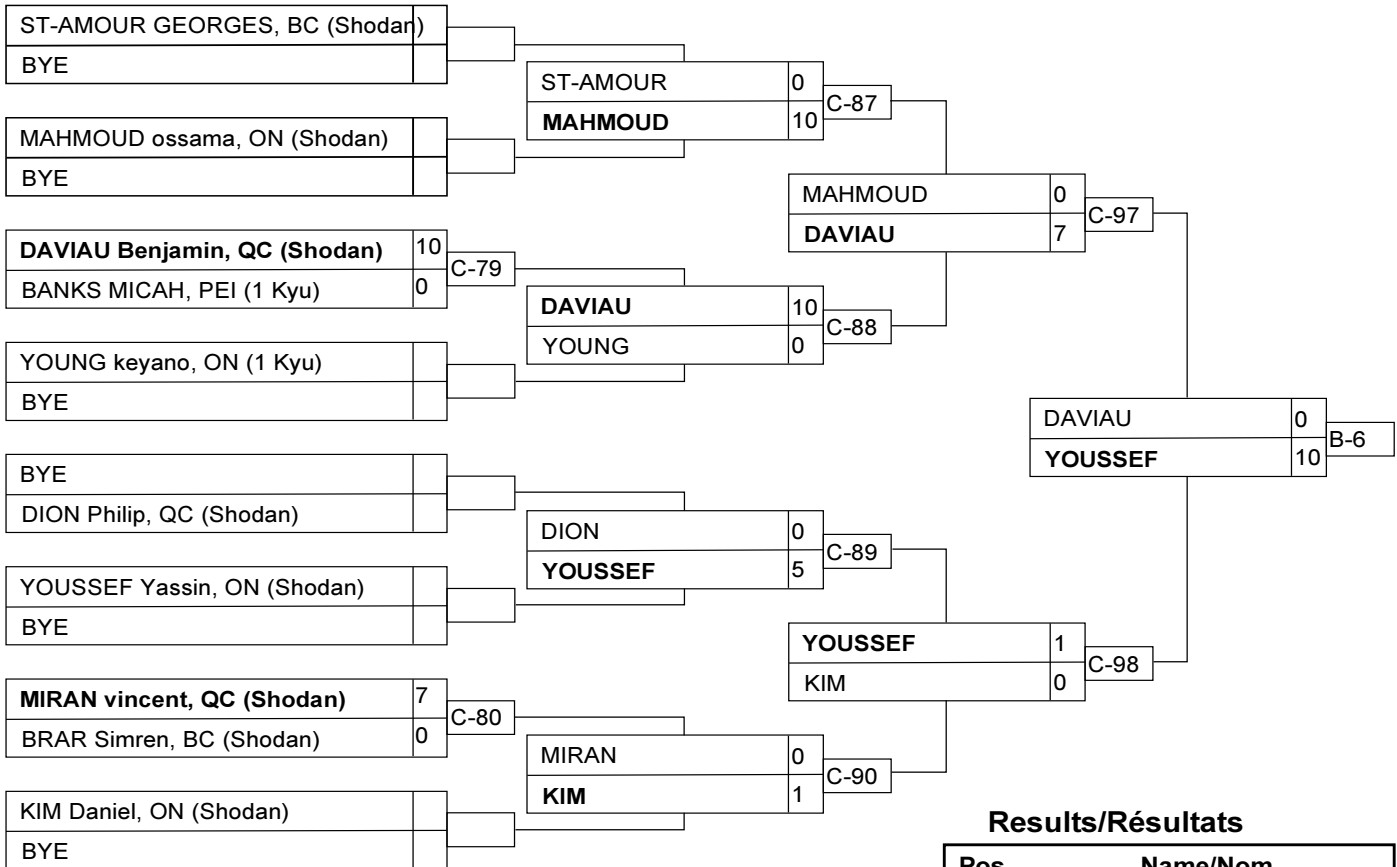

Results/Résultats

Pos	Name/Nom
1	YOUSSEF Yassin, ON (Shodan)
2	DAVIAU Benjamin, QC (Shodan)
3	MAHMOUD ossama, ON (Shodan)
3	KIM Daniel, ON (Shodan)

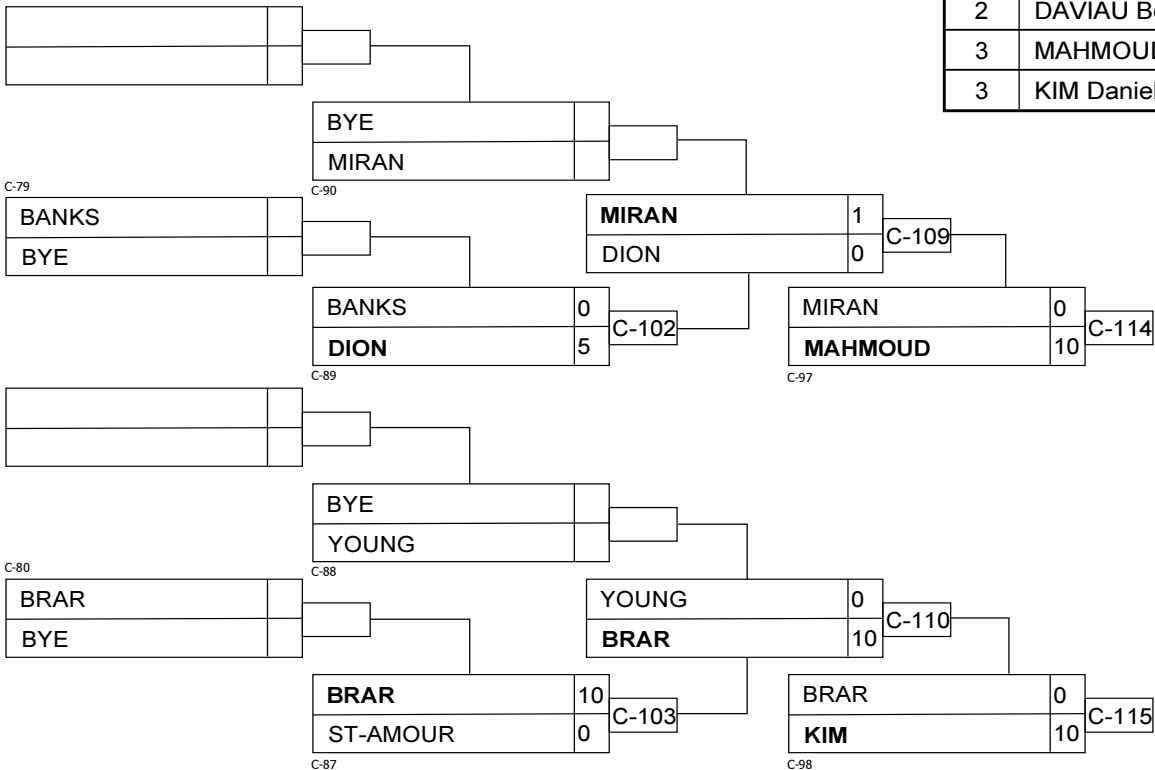

U21 M66

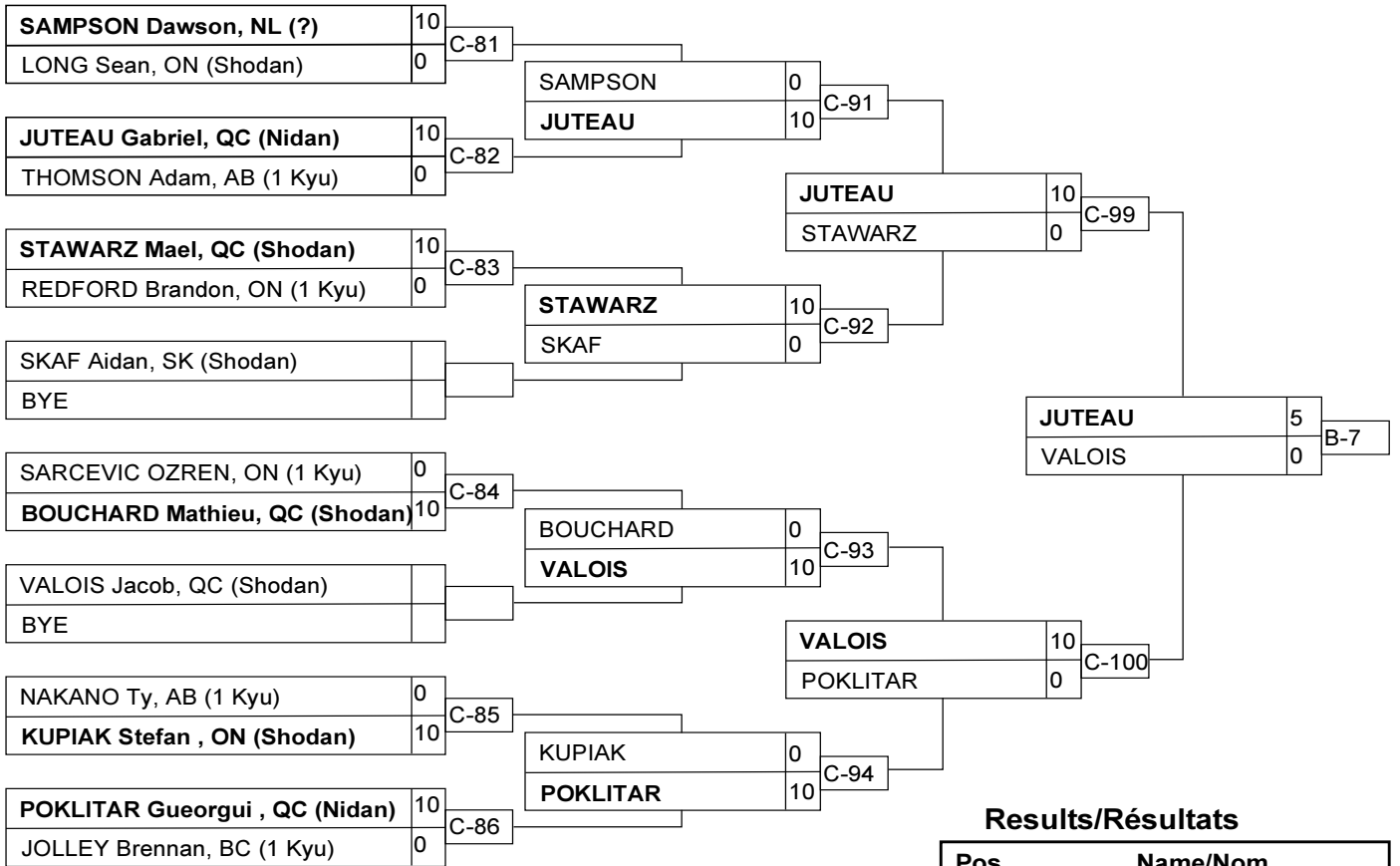

Results/Résultats

Pos	Name/Nom
1	JUTEAU Gabriel, QC (Nidan)
2	VALOIS Jacob, QC (Shodan)
3	STAWARZ Mael, QC (Shodan)
3	POKLITAR Gueorgui, QC (Nidan)

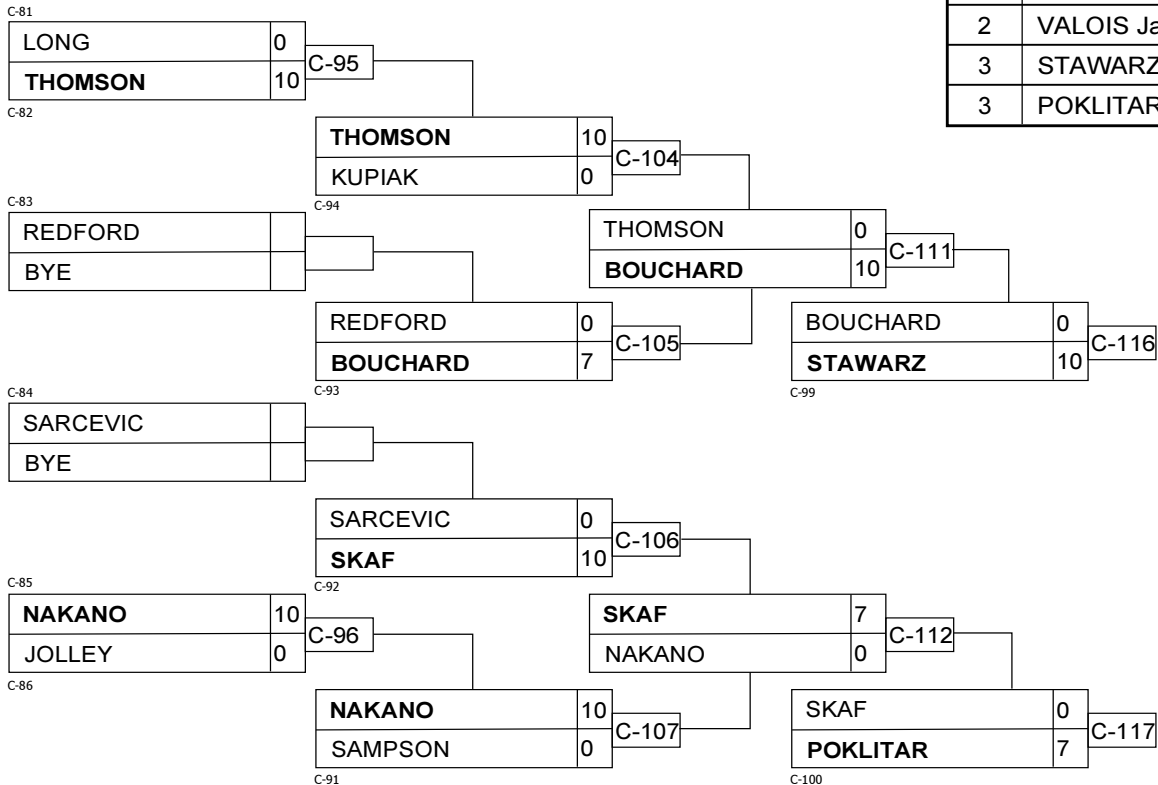

U21 M73

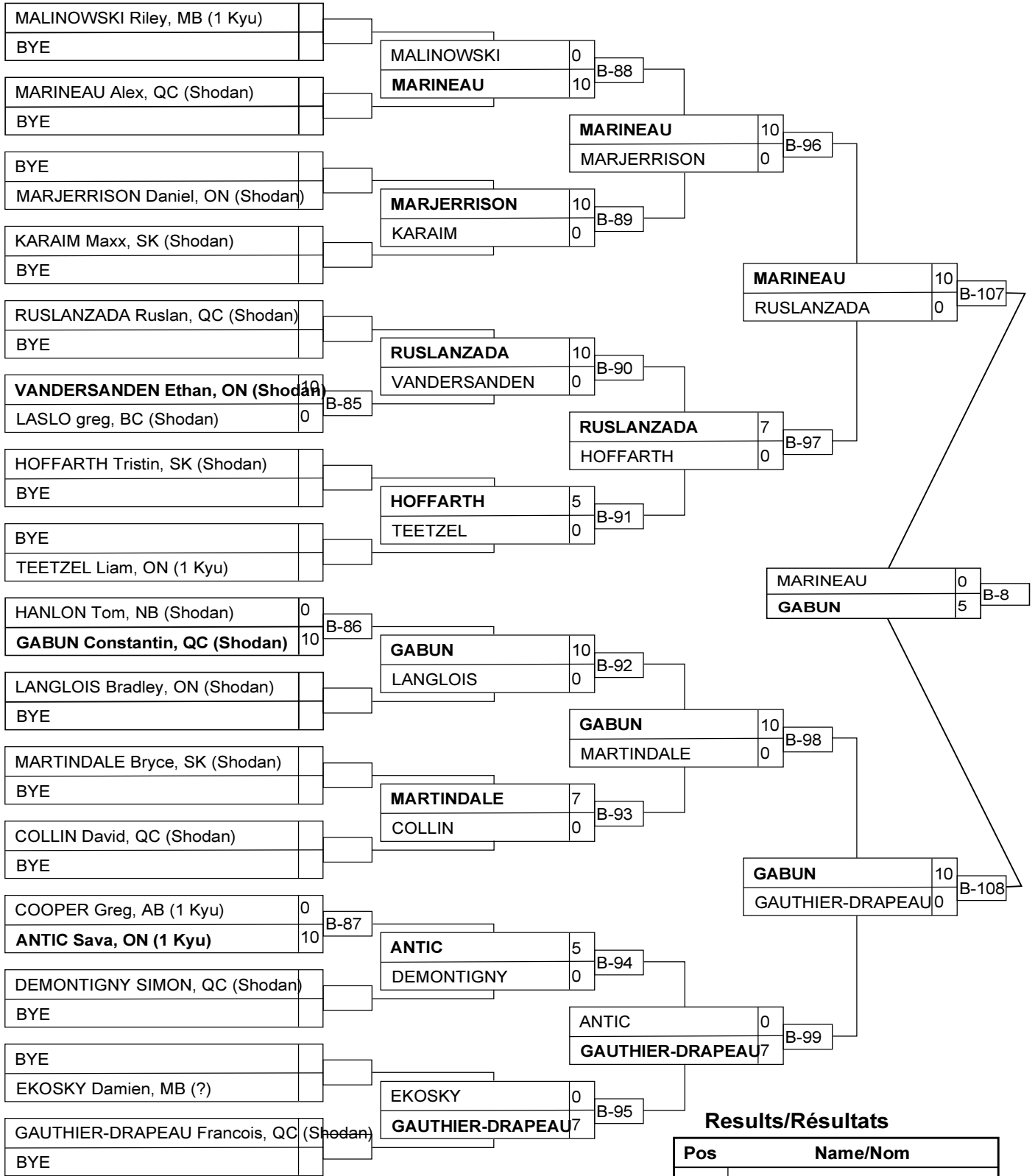

Results/Résultats

Pos	Name/Nom
1	GABUN Constantin, QC (Shodan)
2	MARINEAU Alex, QC (Shodan)
3	RUSLANZADA Ruslan, QC (Shodan)
3	GAUTHIER-DRAPEAU Francois, QC (Shodan)

U21 M81

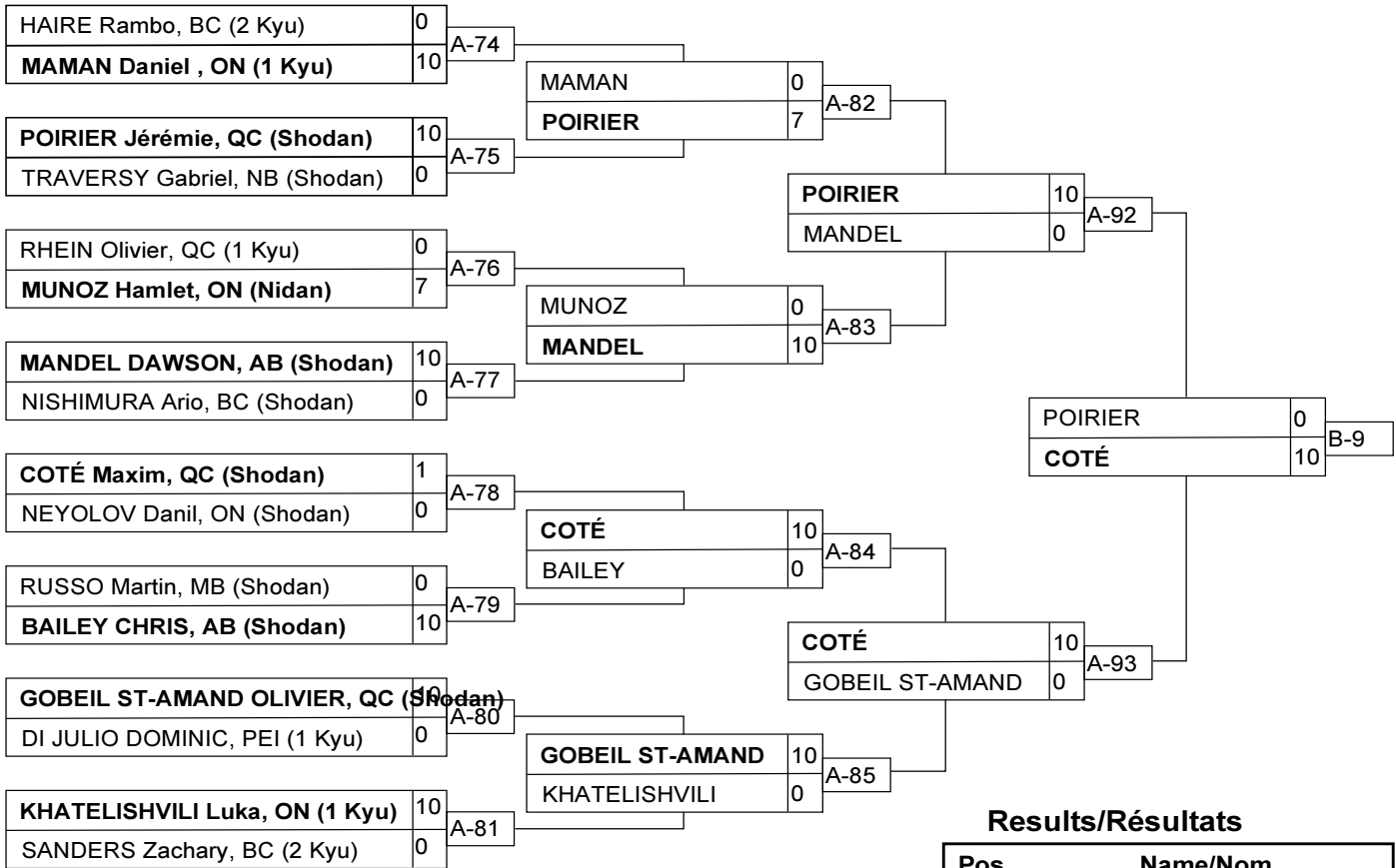

Results/Résultats

Pos	Name/Nom
1	COTÉ Maxim, QC (Shodan)
2	POIRIER Jérémie, QC (Shodan)
3	MANDEL DAWSON, AB (Shodan)
3	GOBEIL ST-AMAND OLIVIER, QC (Shoda)

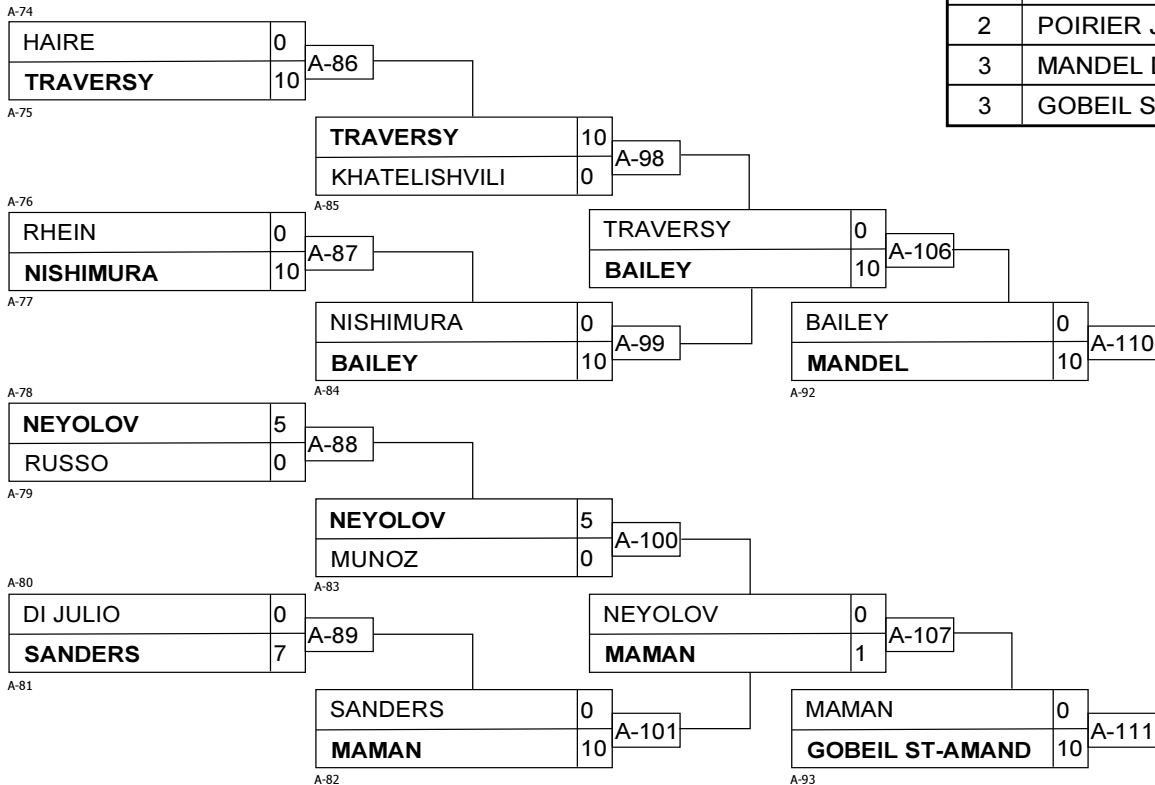

U21 M90

Competitors/Compétiteurs

#	Name/Nom	Grade	Club	1	2	3	4	W/G	Pts	Pos
1	BADAT Thomas	1 Kyu	QC	XX		10		1	10	2
2	EL NAHAS Mohab	Shodan	ON	10	XX	10	10	3	30	1
3	KRIEBER-GAGNON Louis	Nidan	QC			XX	10	1	10	3
4	COLPITTS Alex	Shodan	NB	7			XX	1	7	4

Matches/Matches

Match	White/Blanc			Blue/Bleu	Res/Rés	Tim/Tmp	Code
B-109	BADAT Thomas	1	2	EL NAHAS Mohab	0 - 10	2:51	IPO
B-110	KRIEBER-GAGNON Louis	3	4	COLPITTS Alex	10 - 0	0:45	IPO
B-115	BADAT Thomas	1	3	KRIEBER-GAGNON Louis	10 - 0	3:24	IPO
B-116	EL NAHAS Mohab	2	4	COLPITTS Alex	10 - 0	3:00	IPO
B-119	BADAT Thomas	1	4	COLPITTS Alex	0 - 7	4:00	WAZ
B-120	EL NAHAS Mohab	2	3	KRIEBER-GAGNON Louis	10 - 0	0:00	FUS

Results/Résultats

Pos	Name/Nom
1	EL NAHAS Mohab, ON
2	BADAT Thomas, QC
3	KRIEBER-GAGNON Louis, QC
4	COLPITTS Alex, NB

U21 M100

Competitors/Compétiteurs

#	Name/Nom	Grade	Club	1	2	3	W/G	Pts	Pos
1	CHOUINARD Yohan	1 Kyu	QC	XX			0	0	3
2	EL NAHAS Shady	1 Kyu	ON	10	XX	10	2	20	1
3	JAMIESON Tavis	Nidan	BC	10		XX	1	10	2

Matches/Matches

Match	White/Blanc			Blue/Bleu	Res/Rés	Tim/Tmp	Code
C-101	CHOUINARD Yohan	1	2	EL NAHAS Shady	0 - 10	0:19	IPO
C-108	CHOUINARD Yohan	1	3	JAMIESON Tavis	0 - 10	1:46	IPO
C-113	EL NAHAS Shady	2	3	JAMIESON Tavis	10 - 0	1:40	IPO

Results/Résultats

Pos	Name/Nom
1	EL NAHAS Shady , ON
2	JAMIESON Tavis, BC
3	CHOUINARD Yohan, QC

U21 M100+

Competitors/Compétiteurs

#	Name/Nom	Grade	Club	1	2	3	4	W/G	Pts	Pos
1	CARRILLOS Alexander	1 Kyu	ON	XX			10	1	10	3
2	GAUTHIER Kevin	Shodan	QC	10	XX	10	10	3	30	1
3	VIENNEAU Andrew	Shodan	NB	7		XX	5	2	12	2
4	BLANEY Andrew	1 Kyu	NB				XX	0	0	4

Matches/Matches

Match	White/Blanc			Blue/Bleu	Res/Rés	Tim/Tmp	Code
A-94	CARRILLOS Alexander	1	2	GAUTHIER Kevin	0 - 10	0:18	IPO
A-95	VIENNEAU Andrew	3	4	BLANEY Andrew	5 - 0	4:00	YUK
A-102	CARRILLOS Alexander	1	3	VIENNEAU Andrew	0 - 7	4:00	WAZ
A-103	GAUTHIER Kevin	2	4	BLANEY Andrew	10 - 0	0:59	IPO
A-108	CARRILLOS Alexander	1	4	BLANEY Andrew	10 - 0	3:28	HAN
A-109	GAUTHIER Kevin	2	3	VIENNEAU Andrew	10 - 0	1:16	WIP

Results/Résultats

Pos	Name/Nom
1	GAUTHIER Kevin, QC
2	VIENNEAU Andrew, NB
3	CARRILLOS Alexander, ON
4	BLANEY Andrew, NB